



Garantía de Calidad

NUEVOS PRODUCTOS 2024





WC SUSTENTA INODORO, TAZA Y TANQUE

Descripción

- Taza elongada compacta, de altura confortable con trampa expuesta.
- Descarga de 2.5 LPD.
- Sistema Vórtice. Para una limpieza total.
- Botón accionador.
- No incluye asiento, se recomiendan asientos AT-1, AT-2, AT-4 y AT-5.



Blanco

WC: PRECIO: \$ 4,439.00

**TAZA
SUSTENTA: PRECIO: \$ 2,663.00**

**TANQUE
SUSTENTA: PRECIO: \$ 1,776.00**

VISTA FRONTAL

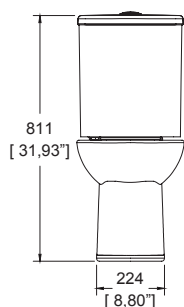

VISTA LATERAL

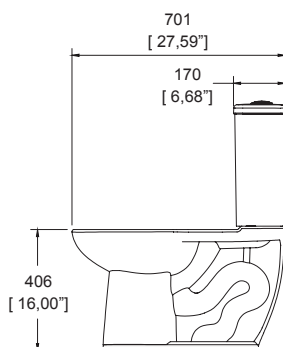

*Los precios incluyen IVA

WC Sustenta 2.5 LPD
Utiliza **58% menos agua**
que un WC promedio



FUSIÓN

Salida electrónica
con dispensador de jabón





Sensor infrarrojo lateral para salida de jabón líquido



FUSIÓN

TV-002

Descripción

- Salida electrónica con dosificador de jabón que opera con un sensor infrarrojo de baterías o corriente.
- La salida se activa sin tocarla, evitando la contaminación cruzada de gérmenes y bacterias.
- No desperdicia agua mientras se enjabona las manos.

Sensor infrarrojo frontal para la salida del agua



PRECIO: \$ 16,334.00

VISTA FRONTAL

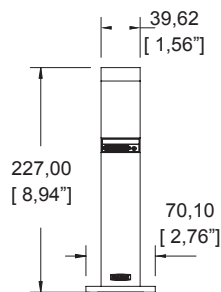

VISTA LATERAL

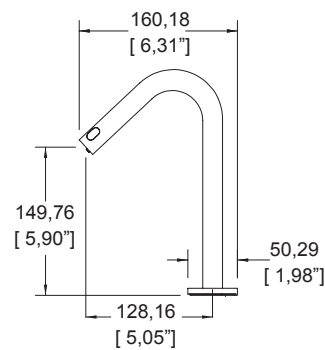

*Los precios incluyen IVA

NUEVOS ACABADOS HELVEX





CLÁSICA E-917-AU

Descripción

- Monomando de lavabo.
- Incluye contra de push Aura.
- Maneral reforzado.
- Incluye inserto para usarse con lavabos sin rebosadero.
- Presión mínima requerida 0.40 kg/cm².



AU
Aura

PRECIO: \$ 6,949.00

VISTA FRONTAL

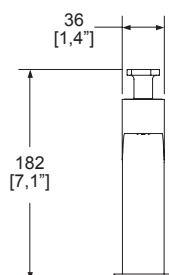

VISTA LATERAL

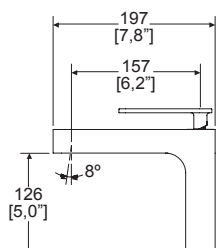

*Los precios incluyen IVA



CENTURY E-708-AU

Descripción

- Monomando para regadera o tina sin desviador.
- Presión mínima requerida 0.80 kg/cm².



AU
Aura

PRECIO: \$ 4,575.00

VISTA FRONTAL

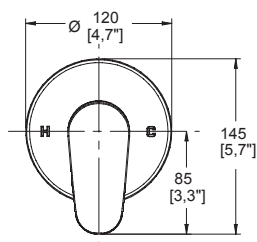

VISTA LATERAL

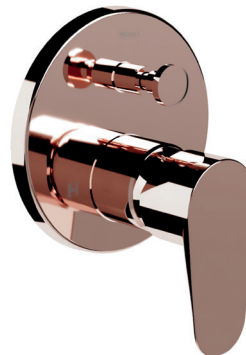
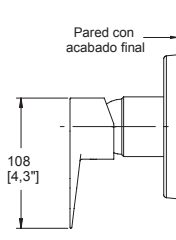

CENTURY E-709-AU

Descripción

- Monomando para regadera, tina o regadera manual con desviador.
- Presión mínima requerida 0.90 kg/cm².



AU
Aura

PRECIO: \$ 5,307.00

VISTA FRONTAL

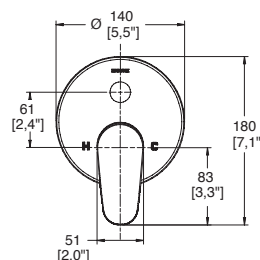

VISTA LATERAL

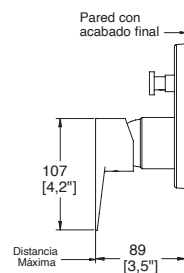

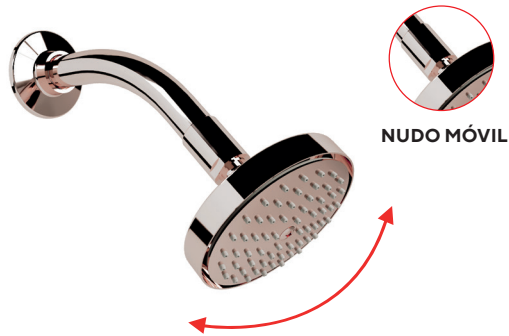

EXPLORA H-201-AU

Descripción

- Regadera de chorro fijo.
- Incluye brazo y chapetón.
- Presión mínima requerida 0.20 kg/cm².
- Consumo máximo de agua: 10 L/min.



AU
Aura

PRECIO: \$ 1,904.00

VISTA FRONTAL

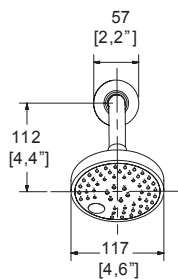

VISTA LATERAL

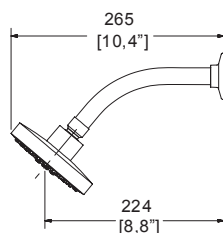

PREMIER H3005-TR035-AU

Descripción

- Regadera de chorro fijo con Tecnología Aireavex.
- Plato ancho de 5" x 8".
- Incluye brazo y chapetón.
- Presión mínima requerida 1.00 kg/cm².
- Consumo máximo de agua: 10 L/min.



AU
Aura

PRECIO: \$ 8,437.00

VISTA FRONTAL

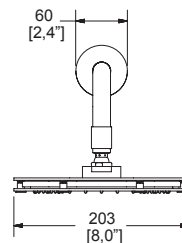

VISTA LATERAL

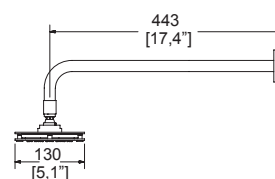

*Los precios incluyen IVA



TUBULAR TUB-05-AU

Descripción

- Toallero de barra.



AU
Aura

PRECIO: \$ 2,558.00

VISTA FRONTAL

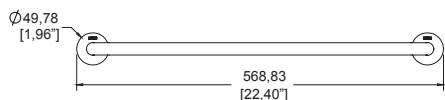

VISTA CENITAL

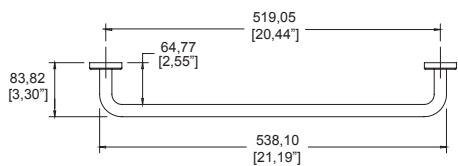

TUBULAR TUB-06-AU

Descripción

- Gancho sencillo.



AU
Aura

PRECIO: \$ 855.00

VISTA FRONTAL

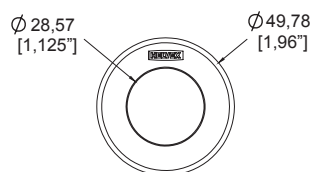

VISTA CENITAL

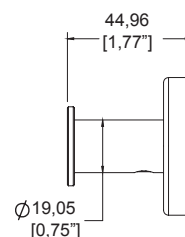



TUBULAR TUB-09-AU

Descripción

- Toallero sencillo.



AU
Aura

PRECIO: \$ 1,265.00

VISTA FRONTAL

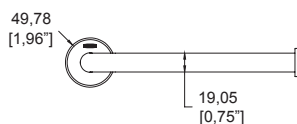

VISTA CENITAL

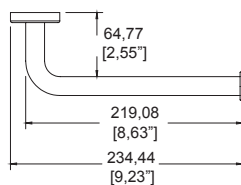

TUBULAR TUB-10-AU

Descripción

- Portatoallas múltiple



AU
Aura

PRECIO: \$ 5,126.00

VISTA FRONTAL

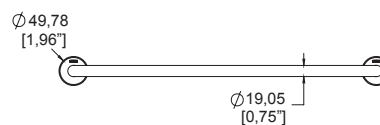

VISTA CENITAL

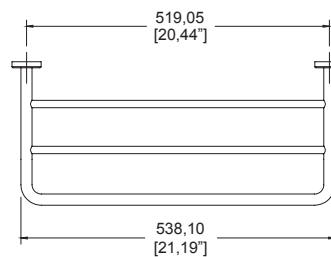

*Los precios incluyen IVA



TUBULAR TUB-17-AU

Descripción

- Portapapel sencillo



AU
Aura

PRECIO: \$ 1,755.00

VISTA FRONTAL

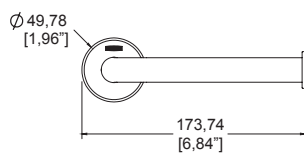

VISTA CENITAL

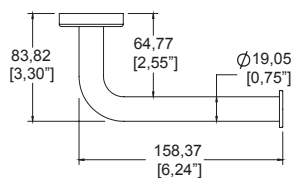

TUBULAR TUB-35-AU

Descripción

- Portapapel con soporte de apoyo tipo barra de seguridad.



AU
Aura

PRECIO: \$ 2,633.00

VISTA FRONTAL

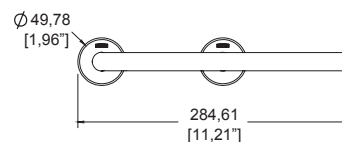

VISTA CENITAL

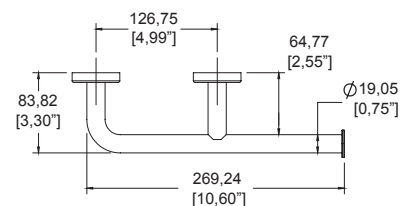



MÀXIMA MEDIANO EP-932-DN

Descripción

- Monomando de lavabo.
- Incluye contra de push Duna.
- Incluye inserto para usarse con lavabos sin rebosadero.
- Presión mínima requerida 0.25 kg/cm².



DN
Duna

PRECIO: \$ 8,400.00

VISTA FRONTAL

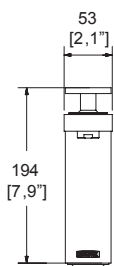

VISTA LATERAL

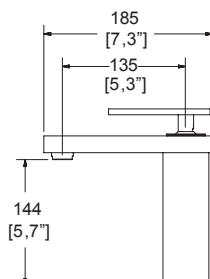

MÀXIMA ALTO EP-933-DN

Descripción

- Monomando de lavabo.
- Incluye contra de push Duna.
- Incluye inserto para usarse con lavabos sin rebosadero.
- Presión mínima requerida 0.25 kg/cm².



DN
Duna

PRECIO: \$ 9,950.00

VISTA FRONTAL

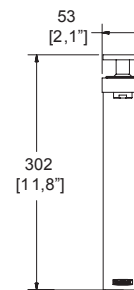

VISTA LATERAL

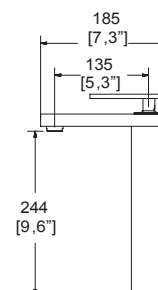

*Los precios incluyen IVA



VÉRTIKA EP-3007-DN

Descripción

- Monomando de lavabo a pared.
- Incluye contra de push Duna.
- Incluye inserto para usarse con lavabos sin rebosadero.
- Presión mínima requerida 1.00 kg/cm².
- Consumo de agua: 5 L/min.



PRECIO: \$ 12,667.00

VISTA FRONTAL

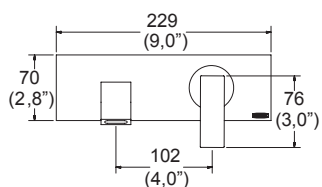

VISTA LATERAL

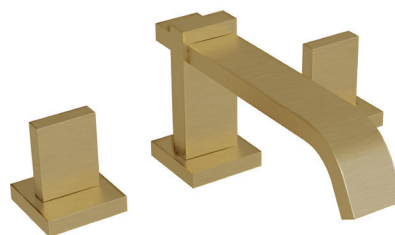
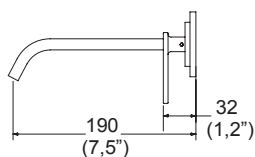

VÉRTIKA MP-1000-DN

Descripción

- Mezcladora de lavabo 8" a 12".
- Incluye contra de push Duna.
- Incluye inserto para usarse con lavabos sin rebosadero.
- Presión mínima requerida 1.00 kg/cm².
- Consumo de agua mínimo de 6 L/min.



PRECIO: \$ 13,516.00

VISTA FRONTAL

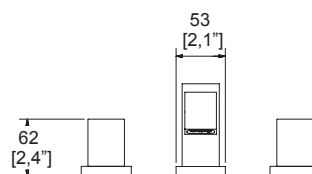

VISTA LATERAL

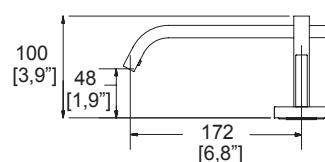

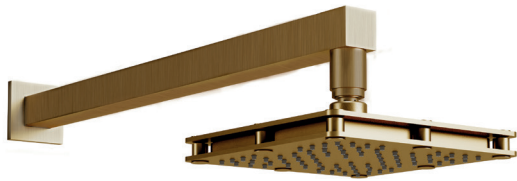

KÚBICA

H3006-TR036-DN

Descripción

- Regadera de chorro fijo con Tecnología Aireavex.
- Plato ancho de 6".
- Incluye brazo y chapetón.
- Presión mínima requerida 1.00 kg/cm².
- Consumo máximo de agua: 9.54 L/min.



DN
Duna

PRECIO: \$ 10,664.00

VISTA FRONTAL

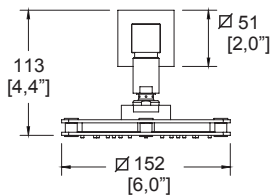

VISTA LATERAL

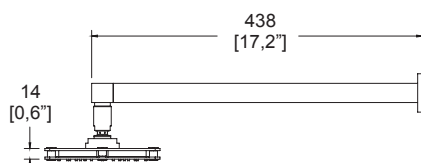

*Los precios incluyen IVA

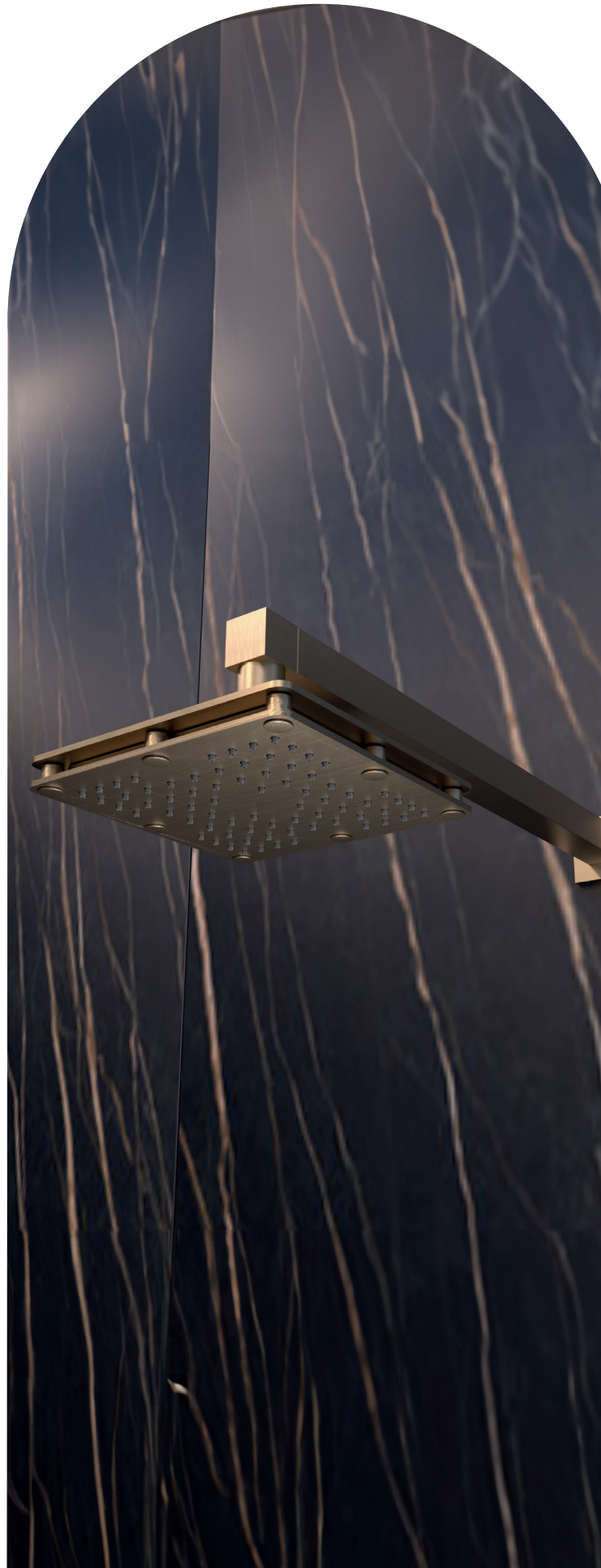



MÁXIMA E-712-DN

Descripción

- Monomando para regadera o tina, sin desviador.
- Presión mínima requerida 0.80 kg/cm².



PRECIO: \$ 4,809.00

VISTA FRONTAL

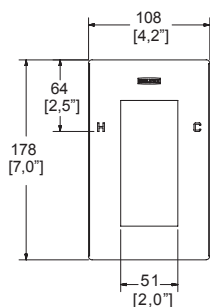

VISTA LATERAL

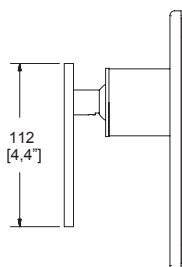

MÁXIMA E-713-DN

DESCRIPCIÓN

- Monomando para regadera o tina, con desviador.
- Presión mínima requerida 1.00 kg/cm².



PRECIO: \$ 5,827.00

VISTA FRONTAL

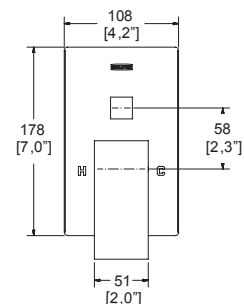

VISTA LATERAL

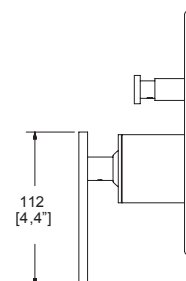



MÁXIMA 20105-DN

Descripción

- Toallero de barra.



DN
Duna

PRECIO: \$ 3,640.00

VISTA FRONTAL

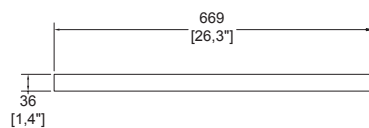

VISTA CENITAL

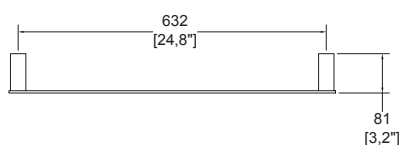

MÁXIMA 20106-DN

Descripción

- Gancho sencillo.



DN
Duna

PRECIO: \$ 889.00

VISTA FRONTAL

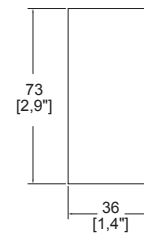

VISTA LATERAL

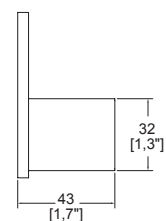

*Los precios incluyen IVA



MÁXIMA 20109-DN

Descripción

- Toallero sencillo.



DN
Duna

PRECIO: \$ 1,965.00

VISTA FRONTAL

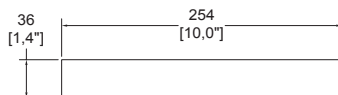

VISTA CENITAL

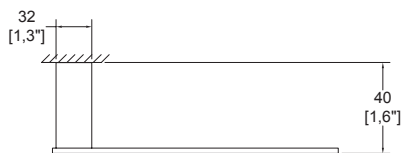

MÁXIMA 20117-DN

Descripción

- Portapapel.



DN
Duna

PRECIO: \$ 2,034.00

VISTA FRONTAL

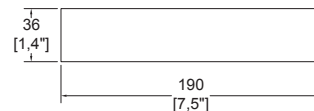

VISTA CENITAL





MAXIMA MEDIANO EP-932-TN

Descripci3n

- Monomando de lavabo.
- Incluye contra de push Titanium.
- Incluye inserto para usarse con lavabos sin rebosadero.
- Presi3n mınima requerida 0.25 kg/cm².



PRECIO: \$ 8,400.00

VISTA FRONTAL

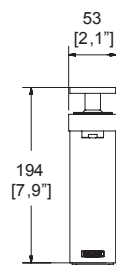

VISTA LATERAL

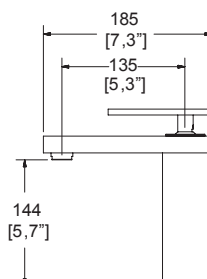

MAXIMA ALTO EP-933-TN

Descripci3n

- Monomando de lavabo.
- Incluye contra de push Titanium.
- Incluye inserto para usarse con lavabos sin rebosadero.
- Presi3n mımima requerida 0.25 kg/cm².



PRECIO: \$ 9,950.00

VISTA FRONTAL

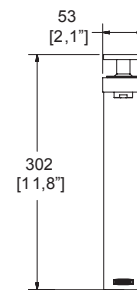

VISTA LATERAL

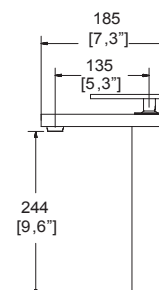

*Los precios incluyen IVA

ACABADO TITANIUM



VÉRTIKA EP-3007-TN

Descripción

- Monomando de lavabo a pared.
- Incluye contra de push Titanium.
- Incluye inserto para usarse con lavabos sin rebosadero.
- Presión mínima requerida 1.00 kg/cm².
- Consumo de agua: 5 L/min.



PRECIO: \$ 12,667.00

VISTA FRONTAL

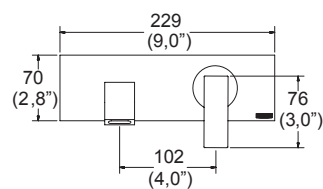

VISTA LATERAL

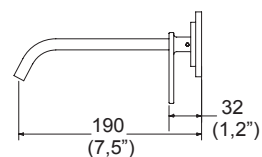

*Los precios incluyen IVA

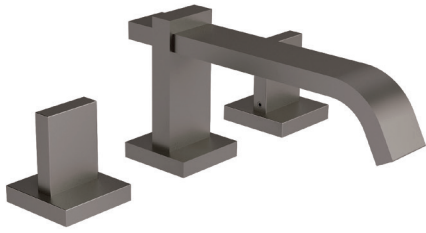

VÉRTIKA MP-1000-TN

Descripción

- Mezcladora de lavabo 8" a 12".
- Incluye contra de push Titanium.
- Incluye inserto para usarse con lavabos sin rebosadero.
- Presión mínima requerida 1.00 kg/cm².
- Consumo de agua mínimo de 6 L/min.



PRECIO: \$ 13,516.00

VISTA FRONTAL

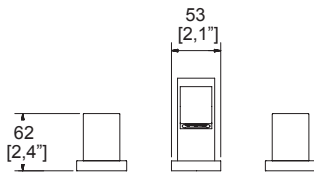

VISTA LATERAL

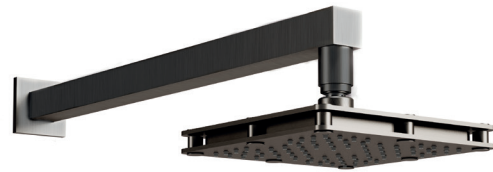
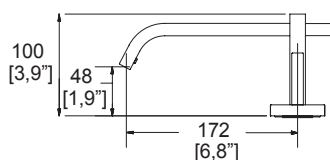

KÚBICA H3006-TR036-TN

Descripción

- Regadera de chorro fijo con Tecnología Aireavex.
- Plato ancho de 6".
- Incluye brazo y chapetón.
- Presión mínima requerida 1.00 kg/cm².
- Consumo máximo de agua: 9.54 L/min.



PRECIO: \$ 10,664.00

VISTA FRONTAL

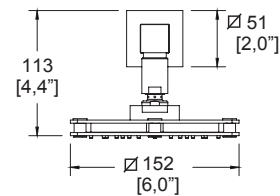

VISTA LATERAL

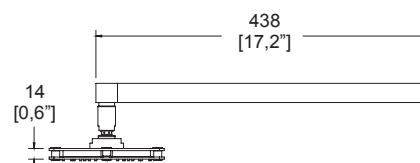

*Los precios incluyen IVA



MXIMA E-712-TN

Descripci3n

- Monomando para regadera o tina, sin desviador.
- Presi3n mnima requerida 0.80 kg/ cm².



PRECIO: \$ 4,809.00

VISTA FRONTAL

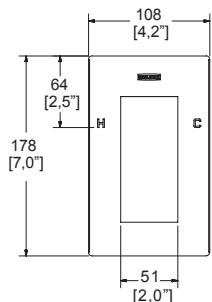

VISTA LATERAL

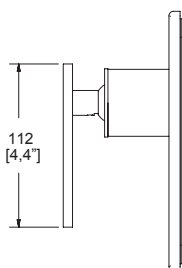

MXIMA E-713-TN

Descripci3n

- Monomando para regadera o tina, con desviador.
- Presi3n mnima requerida 1.00 kg/ cm².



PRECIO: \$ 5,827.00

VISTA FRONTAL

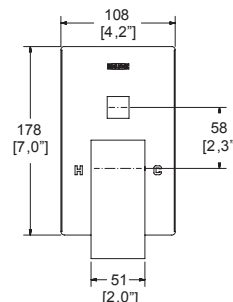

VISTA LATERAL

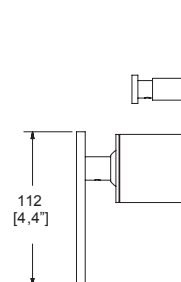



MÁXIMA 20105-TN

Descripción

- Toallero de barra.



PRECIO: \$ 3,640.00

VISTA FRONTAL

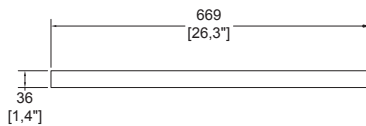

VISTA CENITAL

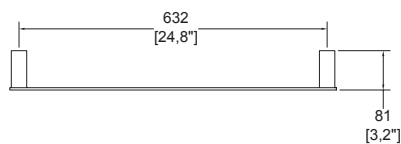

MÁXIMA 20106-TN

Descripción

- Gancho sencillo.



PRECIO: \$ 889.00

VISTA FRONTAL

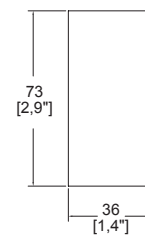

VISTA LATERAL

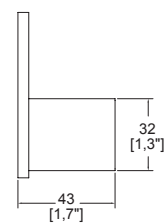

*Los precios incluyen IVA



MÁXIMA 20109-TN

Descripción

- Toallero sencillo.



PRECIO: \$ 1,965.00

VISTA FRONTAL

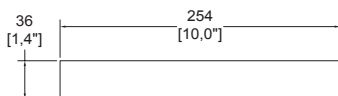

VISTA CENITAL

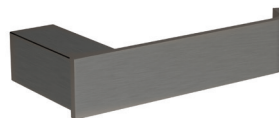
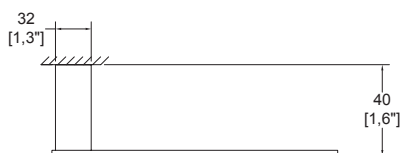

MÁXIMA 20117-TN

Descripción

- Portapapel.



PRECIO: \$ 2,034.00

VISTA FRONTAL

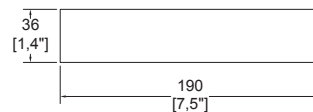

VISTA CENITAL





CLÁSICA

E-917-OB

Descripción

- Monomando de lavabo.
- Incluye contra de push Obsidiana.
- Maneral reforzado.
- Incluye inserto para usarse con lavabos sin rebosadero.
- Presión mínima requerida 0.40 kg/cm².



OB
Obsidiana

PRECIO: \$ 6,949.00

VISTA FRONTAL

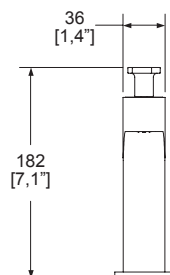

VISTA LATERAL

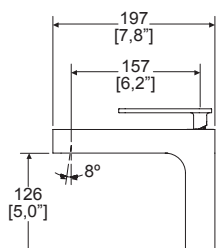

*Los precios incluyen IVA





CENTURY E-708-OB

Descripción

- Monomando para regadera o tina sin desviador.
- Presión mínima requerida 0.80 kg/cm².



OB
Obsidiana

PRECIO: \$ 4,575.00

VISTA FRONTAL

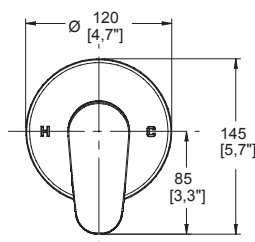

VISTA LATERAL

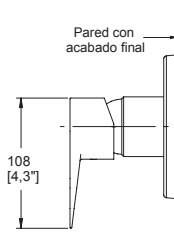

CENTURY E-709-OB

Descripción

- Monomando para regadera, tina o regadera manual con desviador.
- Presión mínima requerida 0.90 kg/cm².



OB
Obsidiana

PRECIO: \$ 5,307.00

VISTA FRONTAL

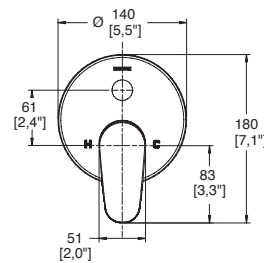

VISTA LATERAL

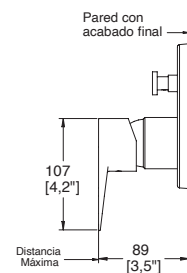



EXPLORA H-201-OB

Descripción

- Regadera de chorro fijo.
- Incluye brazo y chapetón.
- Presión mínima requerida 0.20 kg/cm².
- Consumo máximo de agua: 10 L/min.



PRECIO: \$ 1,904.00

VISTA FRONTAL

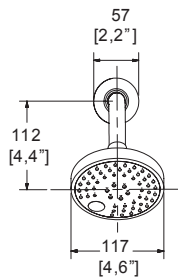

VISTA LATERAL

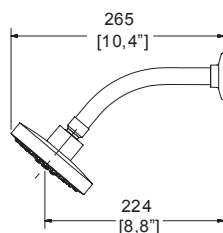

PREMIER H3005-TR035-OB

Descripción

- Regadera de chorro fijo con Tecnología Aireavex.
- Plato ancho de 5" x 8".
- Incluye brazo y chapetón.
- Presión mínima requerida 1.00 kg/cm².
- Consumo máximo de agua: 10 L/min.



PRECIO: \$ 8,437.00

VISTA FRONTAL

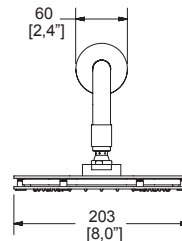

VISTA LATERAL

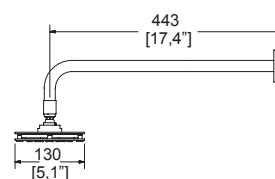

*Los precios incluyen IVA



TUBULAR TUB-05-OB

Descripción

- Toallero de barra.



OB
Obsidiana

PRECIO: \$ 2,558.00

VISTA FRONTAL

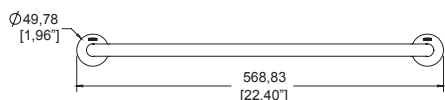

VISTA CENITAL

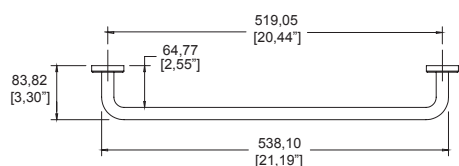

TUBULAR TUB-06-OB

Descripción

- Gancho sencillo.



OB
Obsidiana

PRECIO: \$ 855.00

VISTA FRONTAL

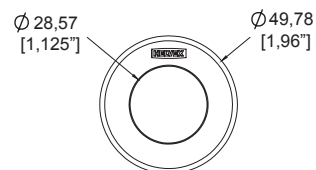

VISTA CENITAL

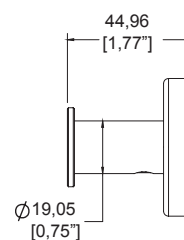



TUBULAR TUB-09-OB

Descripción

- Toallero sencillo.



PRECIO: \$ 1,265.00

VISTA FRONTAL

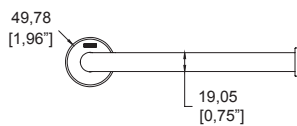

VISTA CENITAL

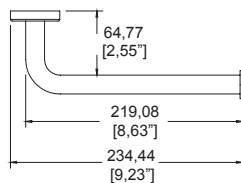

TUBULAR TUB-10-OB

Descripción

- Portatoallas múltiple



PRECIO: \$ 5,126.00

VISTA FRONTAL

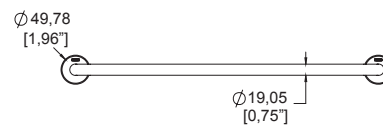

VISTA CENITAL

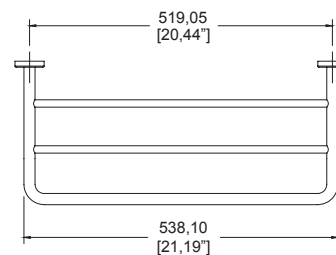

*Los precios incluyen IVA



TUBULAR TUB-17-OB

Descripción

- Portapapel sencillo.



PRECIO: \$ 1,755.00

VISTA FRONTAL

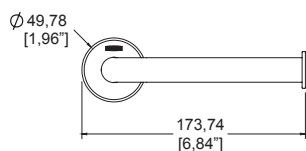

VISTA CENITAL

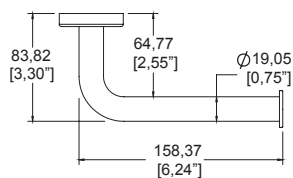

TUBULAR TUB-35-OB

Descripción

- Portapapel con soporte de apoyo tipo barra de seguridad.



PRECIO: \$ 2,633.00

VISTA FRONTAL

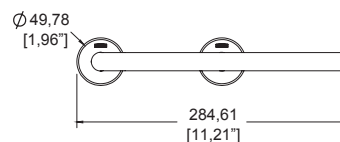

VISTA CENITAL

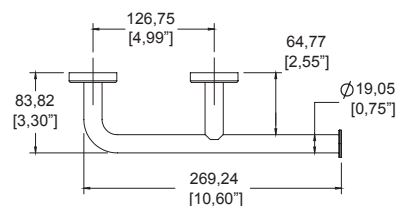



TRANQUILIDAD ES,
ELEGIR LA MARCA CORRECTA

- Durabilidad & Confort
- Refacciones & Servicio técnico
- Garantía



65 Años en
Cerámicos



10 Años en
Grifería en cromo