

LISTA DE PRECIOS REFACCIONES GRIFERÍA Y CERÁMICA

No. 40

JUNIO 2023

Refacciones Originales



garantía de calidad



R E F A C C I O N E S
GRIFERÍA Y CERÁMICA

**CONSULTA Y ASESORÍA
EN REFACCIONES**

refaccioneshelvex.com.mx



(55) 8071 7454



(55) 5333 9421

Refacciones Originales

HELVEX^{M.R.}

garantía de calidad

**TU TRANQUILIDAD ES ELEGIR
REFACCIONES ORIGINALES HELVEX**



 (55) 5333 9421

 55 8071 7454

 refacciones@helvex.com.mx

refaccioneshelvex.com.mx

ÍNDICE

- 06** Llaves y mezcladoras
- 16** Accesorios
- 18** Coladeras
- 21** Valvulas y varios
- 26** Fluxómetros
- 33** Regaderas
- 37** Especiales
- 38** Cerámicos
- 40** Hojas cerámicas

GUÍA TÉCNICA















- 83** Cartuchos
- 89** Émbolos
- 92** Valvex
- 95** Aireadores
- 101** Econimizadores de regadera
- 103** Coladeras
- 115** Coladeras cortas
- 116** Cerámicos

DISTRIBUIDORES

















- 122** Distribuidores autorizados

LLAVES Y MEZCLADORAS





Modelo	Descripción	Precio	Modelo	Descripción	Precio
 RH-002	O'ring 2-012	\$ 5.09	 RH-010	O'ring 2-111	\$ 3.09
 RH-003	Asiento fijo Val-Vex	\$ 8.14	 RH-011	O'ring 2-021	\$ 3.78
 RH-004	Casquillo guía Val-Vex	\$ 68.15	RH-012	Torre contratuerca cuerpo	\$ 133.70
 RH-005	Tornillo asiento Val-Vex 8-18 x 1/4"	\$ 3.77	 RH-016	Asiento vulcanizado Val-vex central	\$ 63.71
 RH-006	Asiento de hule Val-Vex	\$ 4.80	RH-021	Niple unión cuerpo triple	\$ 134.90
 RH-007	Casquillo deslizable izquierdo	\$ 64.99	RH-022	Tuerca cople cuerpo triple	\$ 95.35
 RH-008	Vástago elevador izquierdo	\$ 82.02	 RH-025	Tornillo Phillips No. 8-32 UNC x 1"	\$ 4.30
 RH-009	Rondana vástago Val-Vex	\$ 8.14	RH-026	Rondana polietileno maneral	\$ 5.03
			 RH-027	Tornillo Phillips No. 8-32 UNC x 1 1/4"	\$ 5.03
			 RH-038	Tornillo ranurado No. 8-32 UNC x 3/8"	\$ 2.80

LLAVES Y MEZCLADORAS

Modelo	Descripción	Precio	Modelo	Descripción	Precio
 RH-041	Vástago elevador largo	\$ 161.92	 RH-126	Torre contratuerca chica	\$ 45.40
 RH-042	Tornillo Phillips No. 8-32 UNC x 1/2"	\$ 15.69	 RH-127	O'ring 2-018	\$ 4.43
RH-045	Tapón maneral diamante Cr	\$ 19.30	RH-129	Tuerca hexagonal cuerpo lateral	\$ 89.05
RH-049	Tapón "C" maneral Flair grande	\$ 84.36	RH-141	Torre contratuerca mediana	\$ 85.77
RH-050	Tapón "F" maneral Flair grande	\$ 84.36	 RH-144	Tapón de hule desagüe cadena	\$ 49.82
RH-051	Maneral Flair Tr	\$ 270.14	RH-152	Rejilla para contra desg. de lavabo	\$ 52.35
RH-052	Base maneral Flair grande	\$ 169.26	 RH-162	O'ring 2-205	\$ 3.17
RH-085	Tapón macho cuerpo duplex	\$ 61.87	RH-170	Empaque plano cuerpo central	\$ 12.82
RH-088	Tuerca contra desagüe lavabo	\$ 93.25	 RH-177	Rondana de hule para chapetón	\$ 30.44
 RH-089	Rondana polietileno contra lavabo	\$ 6.97	RH-178	Porta base maneral grande diamante	\$ 20.86
 RH-090	Empaque cónico contra lavabo	\$ 23.92	RH-206	Regadera para Bidet Cr	\$ 275.69
 RH-095	Asiento delrin para esfera	\$ 8.14	 RH-217	O'ring 2-118	\$ 5.03
RH-097	Tuerca sujetadora varilla	\$ 72.48	 RH-220	O'ring 2-115	\$ 4.43
 RH-102	Tornillo gancho elevador	\$ 3.78	 RH-227	Casquillo deslizable derecho Valvex	\$ 64.99
 RH-103	Tuerca para gancho elevador	\$ 0.90	RH-228	Vástago elevador Val-Vex derecho	\$ 82.02
RH-108	Casquillo desviador central	\$ 62.41	 RH-253	O'ring 2-011	\$ 2.53
RH-109	Rondana de latón tuerca unión	\$ 10.49			
RH-113	Asiento fijo Val-Vex central	\$ 11.96			
RH-115	Tuerca hexagonal espárrago	\$ 34.06			
RH-117	Separador cuerpo central	\$ 16.50			
RH-119	Espárrago largo	\$ 90.22			



LLAVES Y MEZCLADORAS

Modelo	Descripción	Precio
RH-274	Tornillo Phillips No.8-32 NC x 9/16"	\$ 17.72
 RH-275	Tornillo No. 10-24 UNC x 3/4"	\$ 21.43
RH-276	Rondana cónica para desagüe	\$ 14.76
RH-277	Tuerca desagüe automático	\$ 113.44
RH-287	Rondana hule codo inferior desag tina	\$ 31.34
RH-290	Tubo codo inferior 1-1/2" x 6-7/8"	\$ 150.74
RH-296	Tubo unión para desagüe de tina	\$ 85.77
RH-299	Contra desagüe tapón y cadena	\$ 418.73
RH-302	Birlo de contracanasta	\$ 89.58
RH-306	Sello para contracanasta	\$ 21.49
RH-307	Rondana de hule contracanasta	\$ 52.99
RH-308	Rondana contracanasta	\$ 24.62
RH-311	Tubo unión contracanasta p/ fregadero	\$ 143.00
 RH-313	Vástago Val-Vex II largo 1" astriado	\$ 241.09
 RH-337	O'ring 2-114	\$ 3.78
 RH-345	O'ring 2-112	\$ 3.17
RH-356	Rondana delrin cpo lat.	\$ 4.86
 RH-365	Botón varilla elevadora Elite	\$ 88.74
RH-378	Rondana espárrago	\$ 5.03
RH-394	Espárrago largo	\$ 108.80
RH-399	Tornillo Phillips No.8-32 UNC-2a x 1"	\$ 18.84

Modelo	Descripción	Precio
RH-416	Vastago salida tina cr.	\$ 64.53
RH-417	Maneral chico Albatros palanca izq.	\$ 248.25
 RH-418	O'ring 2-017	\$ 5.03
RH-419	Espaciador de contracanasta	\$ 68.95
RH-423	Tuerca unión tubo contra	\$ 204.96
RH-424	Contratuerca del espaciador	\$ 146.95
RH-427	O'ring 2-029	\$ 19.58
 RH-443	Empaque de hule Val-Vex II	\$ 7.27
 RH-444	Asiento delrin Val-Vex II	\$ 13.53
RH-467	Torre contratuerca alta	\$ 128.02
RH-468	Vástago elevador corto izquierdo	\$ 73.80
RH-483	O'ring 2-224	\$ 6.97
 RH-502	Resorte Sal. Tina Elite	\$ 26.15
RH-529	Tornillo No. 8-32 UNC	\$ 4.43
RH-542	Sello Sal. Tina	\$ 36.52
 RH-612	Chapetón 1-1/8" c/cuerda p/man.1 1/8"	\$ 160.63
 RH-613	Tuerca 1-1/2" 24 UNS-2a	\$ 170.26
 RH-614	O'ring 2-124	\$ 7.99
RH-620	Espárrago 5/16" 18 UNC-2a	\$ 41.53
RH-621	Tuerca 5/16" 18 UNS-2b	\$ 39.18
RH-634	O'ring 2-009	\$ 11.96
RH-641	O'ring 2-136	\$ 8.78
RH-664	Adapt sal Antiqua	\$ 148.27
RH-667	Opresor No. 8-32 x 1/4"	\$ 7.23
RH-690	Torre contratuerca	\$ 112.16
RH-700	Espárrago corto	\$ 71.82

LLAVES Y MEZCLADORAS

Modelo	Descripción	Precio
 RH-703	O'ring 2 -117	\$ 4.43
 RH-741	O'ring 2-016	\$ 2.29
RH-759	Botón maneral Europeo CR.	\$ 61.87
RH-799	Porta base maneral grande Flair	\$ 21.49
RH-827	Cuerpo Val-Vex II	\$ 102.54
RH-828	Vástago grande Val-Vex II	\$ 88.11
RH-829	Vástago chico Val-Vex II	\$ 79.12
 RH-830	Disco fricción Val-Vex II	\$ 57.41
 RH-831	Plato superior cerámica	\$ 62.33
 RH-832	Plato inferior cerámica	\$ 62.33
RH-834	Rondana vástago Val-Vex II	\$ 21.80
RH-854	Varilla elevadora 3/16" X 11"	\$ 218.27
RH-916	Chapetón monomando 1 5/8"	\$ 203.12
RH-916-S	Chapetón monomando 1 5/8" satin	\$ 223.49
RH-917	Tuerca monomando 1 5/8"	\$ 121.61
 RH-930	Tubo unión céspol y contra p/lavabo	\$ 203.61
RH-930-S	Tubo unión céspol y contra p/lavabo satin	\$ 226.28
RH-932	Extensión superior contra	\$ 231.61
RH-971	Empaque de teflón	\$ 24.04
RH-972	Empaque para cuerpo mezclador	\$ 44.02
RH-973	Empaque hule base roscada p/E-34	\$ 56.84
RH-1047	Empaque para cuerpo central	\$ 16.02

 RH-1048	Espárr. p/salida de cámara seca lav.	\$ 78.27
 RH-1065	Casquillo con buje para valvex central	\$ 103.53

Modelo	Descripción	Precio
RH-1077	Sello esparrago mon. de fregadero	\$ 49.33
RH-1109	Junta unión	\$ 36.76
RH-1130	Tornillo Phillips 8-32 x 1"11-16	\$ 5.77
RH-1140	Chap. deslizable para maneral Nuva	\$ 277.85
RH-1152	O'ring 2-014	\$ 5.57
RH-1169	O'ring 2-126	\$ 1.98
RH-1185	Casquillo de sujeción maneral	\$ 34.65
RH-1186	Extensión macho maneral Nuva	\$ 141.29
RH-1186-S	Extensión macho man. Nuva satin	\$ 155.45
RH-1187	Buje extensión macho para maneral	\$ 85.29
RH-1187-S	Buje extensión macho para maneral satin	\$ 93.87
RH-1188	Botón para maneral Nuva	\$ 60.78
RH-1188-S	Botón para maneral Nuva satin	\$ 66.86
RH-1193	Tuerca	\$ 64.00
RH-1237	Esfera p/casquillo Valvex central	\$ 5.97
RH-1242	Llave hexagonal 1 1/16"	\$ 92.05
RH-1264	Extensión para ensamble E-50	\$ 108.20
RH-1272	Tornillo de 8-32 UNC 2A x 3/4"	\$ 6.64
RH-1278	Chap. base para monomando Nuva	\$ 233.71
RH-1278-S	Chap. base para mon. Nuva Satin	\$ 257.08
RH-1279	Espárrago	\$ 114.97
RH-1280	Tuerca de sujeción monomando	\$ 92.95

 RH-1282	Separador cuerpo central	\$ 16.01
---	--------------------------	----------

 RH-1284	Rondana de latón monomando lateral	\$ 35.96
---	------------------------------------	----------

RH-1302	Empaque para varilla de desagüe	\$ 7.18
RH-1329	Chapetón salida monomando	\$ 237.27
RH-1329-S	Chapetón salida monomando satin	\$ 261.28
RH-1334	O'ring 2-019	\$ 2.92
RH-1380	Rondana de hule para mezcladora HM	\$ 3.47
RH-1382	Empaque para mezcladora lavabo HM	\$ 9.66
RH-1385	Empaque para chap. d mezcladora freg.	\$ 16.72

 RH-1393	Aireador para salida Nuva	\$ 226.39
---	---------------------------	-----------

 RH-1395	Llave para aireador	\$ 13.36
---	---------------------	----------

RH-1444	O'ring 2-120	\$ 6.62
RH-1453	Espárrago para salida de lavabo	\$ 219.34
RH-1458	Botón varilla elevadora Miura	\$ 145.50

LLAVES Y MEZCLADORAS

Modelo Descripción Precio



RH-1459 Espárrago grande salida Miura \$ 233.76

RH-1463 Chapetón para maneral Miura \$ 416.07
RH-1467 Tornillo sujeción maneral Voga y Argenta \$ 84.29
RH-1471 Tuerca espárrago salida Miura \$ 99.88
RH-1472 Rondana de latón salida Miura \$ 19.29



RH-1473 Separador cuerpo central \$ 13.06

RH-1486 Llave hexagonal 1-1/4" \$ 127.70
RH-1557 Tornillo especial 8-32 unc \$ 56.53
RH-1598 Buje de plástico \$ 39.01
RH-1613 Rondana delrin \$ 20.86
RH-1620 Espárrago para monomando fregadero \$ 426.71
RH-1636 O'ring 2-320 \$ 15.14
RH-1649 Boquilla para aireador E-300 \$ 88.91
RH-1661 Buje conector p/salida de lavabo y freg \$ 20.53
RH-1662 Rondana antifriccion p/salida lav y freg \$ 31.70
RH-1730 Cuerpo para maneral Vértika \$ 313.81
RH-1731 Chapetón cuadrado para maneral Vértika \$ 285.31
RH-1732 Base chapetón para maneral Vértika \$ 245.31
RH-1747 Contratuerca p/cpo. d/empotrar de reg. \$ 49.69
RH-1762 Buje para salida de fregadero \$ 7.80
RH-1765 Chapetón p/sal ens. freg. E-301, E-302 CR \$ 292.00
RH-1767 Antifricción inferior para salida fregadero \$ 5.49
RH-1778 Empaque para salida de fregadero \$ 11.62
RH-1780 Empaque p/chapetón maneral Kúbica \$ 3.77
RH-1782 Opresor Allen 5-40 UNC \$ 16.02
RH-1783 Empaque p/chapetón de salida lav y freg \$ 4.74
RH-1786 Extensión vástago maneral Konos \$ 171.25
RH-1802 Tuerca para monomando fregadero \$ 108.74
RH-1849 Espárrago p/mezc. lav. Acueducto Vértika \$ 294.23
RH-1864 Tuerca conector para espárrago \$ 55.29
RH-1868 Empaque p/base sal. lav. Acueducto Vértika \$ 19.22
RH-1875 Chapetón p/maneral Magna cromo \$ 403.36
RH-1876 Extensión palanca maneral \$ 88.75



RH-1889 Empaque para diafragma push de tina \$ 26.81

RH-1913 Cuerpo contra c rebosadero p/lavabo \$ 316.68
RH-1914 Cuerpo contra p/lavabo SREB \$ 316.68
RH-1943 Cúpula p/contra push de lavabo cromo \$ 244.90
RH-1943-S Cúpula p/contra push de lavavo S \$ 269.44
RH-1944 Rejilla p/contra push de lavabo cromo \$ 117.82
RH-1945 Extensión p/contra push de lavabo cromo \$ 246.47

Modelo Descripción Precio



RH-1946 Empaque p/contra push de lavabo \$ 12.73

RH-1986 Tuerca de sujeción cartucho 25mm \$ 88.71
RH-2006 Tuerca fijación de chapetón mon. lav. pared \$ 154.25
RH-2008 Maneral p/monomando lavabo Vértika /Cr. \$ 409.04
RH-2009 Tapa deslizante p/monomando lavabo \$ 112.78
RH-2011 Pistón p/cartucho monomando de reg \$ 181.19
RH-2016 Pistón p/monomando de lavabo acueducto \$ 194.02
RH-2019 Tuerca fijación de porta. cart. mon. lav. pared \$ 79.36
RH-2020 Empaque amortiguador \$ 23.51
RH-2021 Rondana antifricción \$ 16.26
RH-2022 Varilla ajuste mon. lav. pared acue-Vértika \$ 191.33
RH-2023 Llave p/tuerca mon. lav. pared Vértika \$ 45.02
RH-2036 Tornillo ajust. porta. cart. Vértika-Premier \$ 30.30
RH-2038 Empaque neopr. mzc. lav. acueducto Vértika \$ 11.86
RH-2118 Placa d/sujeción monom. freg. E-305 \$ 120.14



RH-2197 Llave p/aireador oculto M24x1 \$ 39.54

RH-2201 Opresor 8-32 UNC 2A x 0.18" \$ 4.09
RH-2202 Empaque p/monomando con inserto \$ 5.10
RH-2207 Empaque p/tapa sal. monom. d/lavabo \$ 33.44
RH-2208 Filtro p/salida monom. lavabo \$ 120.80
RH-2220 Opresor Allen 5-40 UNC X 0.125 \$ 8.35



RH-2223 Llave p/aireador rectangular \$ 49.52

RH-2272 Llave de instalación p/mon. de freg \$ 145.26
RH-2284 Tubo unión p/contra lavabo 30cm \$ 357.60
RH-2368 Empaque cónico salida integra \$ 12.37
RH-2393 Inserto espárrago p/mezcladora \$ 219.90
RH-2437 O'ring 2-221 \$ 2.76
RH-2446 Tuerca de sujeción de cartucho E-306 \$ 146.00
RH-2462 Empaque base para chapetón \$ 20.85
RH-2470 Chapetón p/mezcladora de freg. HM \$ 600.73
RH-2471 Chapetón p/ contratuerca Valvex \$ 133.54
RH-2520 Chapetón p/mezcladora M-1005 \$ 147.35
RH-2549 Cuerpo central tipo "Y" \$ 216.22
RH-2605 Opresor 8-32 UNC 1-1/8 \$ 38.71
RH-2616 Opresor 8-32 UNC X 1 \$ 10.01



RH-2657 Llave para mantenimiento ME-303 \$ 35.45

RH-2670 Opresor 8-32 UNC X11/1 \$ 31.09
RH-2671 Tornillo cabeza de botón 5-40 x 1/4" \$ 2.73

LLAVES Y MEZCLADORAS

Modelo	Descripción	Precio
RH-2676	Rondana antifricción HM-37 HM-38	\$ 7.91
RH-2704	Conector M10 A3/8" p/mon. cocina	\$ 44.46
RH-2731	Emp. para monomando de lavabo	\$ 14.38

	RH-2736 Llave para aireador oculto 15/16"	\$ 31.37
---	--	----------

RH-2739	Sello base monomando lavabo Piura	\$ 33.26
RH-2743	Empaque sello contra lavabo	\$ 13.15
RH-2747	Separador maneral M-1006	\$ 39.63
RH-2834	Rondana antifricción p/chap. de mon	\$ 20.00
SH-023	Varilla armada para contra Óptima	\$ 180.70

	SH-025 Cadena larga desagüe tapón	\$ 228.25
---	--	-----------

SH-029	Manija con chap. varilla arm. cromo	\$ 1,330.52
SH-035	Contra rej. tapón cadena	\$ 453.40
SH-036	Canasta y Buje arm.	\$ 167.14
SH-066	Medio Val-Vex izquierdo	\$ 161.76
SH-074	Chapetón tapón y cadena de tina	\$ 877.80
SH-089	Regadera man. para mon. E-35 y E-36	\$ 971.98
SH-097	Cadena corta desagüe	\$ 124.19

	SH-118 Tapón diafragma desagüe tina	\$ 227.52
---	--	-----------

	SH-127 Canasta con birlo y tapón	\$ 278.11
---	---	-----------

	SH-130 Juego chapetones master sin empaques	\$ 388.57
---	--	-----------

SH-130-S	Juego chap. master sin empaque S	\$ 446.86
-----------------	----------------------------------	-----------

	SH-131 Juego chapetones master con empaques	\$ 449.59
---	--	-----------





	SH-217 Maneral Mantiss armado	\$ 906.57
---	--------------------------------------	-----------

Modelo	Descripción	Precio
	SH-220 Extensión c/asiento p/cpo lateral	\$ 91.03





SH-237	Cuerpo lateral armado Val-Vex II	\$ 1,109.02
SH-251	Contra rejilla soldada	\$ 521.32
SH-253	Varilla elevadora armada cromo	\$ 340.22

	SH-257 Val-Vex V-II cierre disco cerámico	\$ 388.41
---	--	-----------

SH-258	Kit casquillo Val-Vex central	\$ 130.49
---------------	-------------------------------	-----------

	RH-010 O'ring 2-111	
	RH-127 O'ring 2-018	
	RH-1065 Casquillo c/buje p val. central	
	RH-1237 Esfera p/casquillo val. central	

SH-259	Kit casquillo Val-Vex izquierdo	\$ 81.23
---------------	---------------------------------	----------

















	RH-005 Torn. asiento Val-Vex	
	RH-006 Asiento Val-Vex	
	RH-007 Casq. desliz. izq. Val-Vex	
	RH-010 O'ring 2-111	
	RH-127 O'ring 2-018	

	SH-260 Val-Vex grande derecho mecanismo de casquillo	\$ 224.49
---	---	-----------













	SH-261 Val-Vex chico derecho mecanismo de casquillo	\$ 216.86
---	--	-----------

	SH-262 Val-Vex grande izquierdo mecanismo de casquillo	\$ 224.49
---	---	-----------

LLAVES Y MEZCLADORAS

Modelo	Descripción	Precio	Modelo	Descripción	Precio
 SH-263	Val-Vex chico izquierdo mecanismo de casquillo	\$ 216.86	 SH-370	Cartucho monomando GDM lavabo 35mm Diam.	\$ 618.83
 SH-264	Val-Vex central	\$ 355.03	SH-372	Manguera 1/2 x H 3/8" x12" largo	\$ 136.91
 SH-265	Kit de refacción Val-Vex II grande cierre disco cerámico	\$ 396.84	 SH-373	Cartucho monomando para fregadero	\$ 862.29
SH-266	Kit casquillo Val-Vex derecho	\$ 81.23	 SH-374	Cartucho monomando Mantiss	\$ 875.37
 RH-005	Torn. asiento Val-Vex		 SH-383	Cubre taladros monomando cromo	\$ 534.74
 RH-006	Asiento Val-Vex		SH-383-S	Cubre taladros monomando satin	\$ 588.65
 RH-010	O'ring 2-111		SH-392	Cpo. lateral arm. para mangueras	\$ 965.10
 RH-127	O'ring 2-018		SH-393	Cuerpo lateral con Val-Vex II	\$ 1,061.60
RH-227	Casq. desliz. der Val-Vex		 SH-394	Mang. Flex. 3/8" x 1/2" x 12	\$ 227.15
 SH-282	Aireador para salida sin seguro cromo	\$ 150.39	SH-398	Maneral monomando Novus arm. cromo	\$ 781.58
SH-282-L	Aireador para salida laca sin seguro	\$ 180.53	SH-412	Cuello ganso giratorio hospital cromo	\$ 1,070.71
SH-282-S	Aireador para salida satin sin seguro	\$ 180.53	SH-417	Maneral Sable cromo	\$ 726.22
SH-301	Tapón con O'ring para maneral Axiss	\$ 71.27	SH-462	Paquete codo y regadera Bidet	\$ 719.69
SH-306	Tapón acrílico con botón rojo y azul	\$ 69.41	 SH-694	Cabezal p/mon. de freg. E-37 y E-39	\$ 1,494.03
SH-316	Botón "C" para maneral Antiqua	\$ 82.02	 SH-696	Torre contratuerca con O'ring	\$ 49.83
SH-316-L	Botón "C" para maneral Antiqua laca	\$ 98.94	 SH-700	Maneral Axiss armado	\$ 1,022.54
SH-317	Botón "F" para maneral Antiqua	\$ 82.02			
SH-317-L	Botón "F" p/man. Antiqua c/base y/ O'ring laca	\$ 98.94			
SH-318	Botón central Antiqua	\$ 82.02			
SH-321	Varilla elevadora con botón	\$ 386.55			
SH-336	Valvex master	\$ 354.06			
 SH-355	Kit botón europeo con O'ring cromo	\$ 64.87			

LLAVES Y MEZCLADORAS

Modelo	Descripción	Precio	Modelo	Descripción	Precio
SH-748	Paquete de tornillos p/ desag de tina	\$ 42.89	SH-1000	Kit de empaques p/contra de lavado	\$ 30.86
SH-765	Manguera retráctil y p / mon. freg.	\$ 553.08			
SH-786	Contra peso mang. retrac. mon. freg	\$ 151.65			
SH-806	Salida lav. de pared arm. Nuva cromo	\$ 2,895.28			
SH-806-S	Salida lav. de pared arm. Nuva satin	\$ 3,183.38			
SH-827	Cpo. salida de pared Nuva cromo	\$ 858.43	SH-1010	Extensión c/asiento cpo. lat. valvex Vértika	\$ 91.03
SH-827-S	Cpo. salida de pared Nuva satin	\$ 944.27			
	SH-855 Aireador 2.2 GPM llave economizadora	\$ 117.58		SH-1012 Valvex V grande derecho cierre disco cerámico	\$ 340.00
SH-878	Tubo alimentador soldado	\$ 193.31			
SH-881	Varilla elevadora armada	\$ 363.74	SH-1023	Cpo. Lat. derecho arm. p/ lavabo Vértika	\$ 1,662.91
SH-883	Tubo alimentador soldado largo	\$ 206.35	SH-1024	Cpo. Lat. izq arm. para lavabo Vértika	\$ 1,662.91
SH-889	Botón acrílico azul y rojo mon.	\$ 85.89	SH-1027	Extensión superior p/contra rejilla Cr	\$ 298.58
SH-890	Botón c/O'ring para maneral	\$ 95.71	SH-1027-S	Ext. superior para contra rejilla S	\$ 343.00
SH-891	Botón azul y rojo c/O'ring p/man. d/mon.	\$ 106.42	SH-1031	Manguera 3/8 m cuerda x2 9" p/mon lav.	\$ 158.21
SH-915	Manguera "-24 UNS 2a X" 18 NPSM-2B	\$ 223.21			
SH-917	Manguera cuerpo central y tca.	\$ 315.20			
	SH-949 Manguera 1/2H-3/8M-X24 long. F.	\$ 225.20		SH-1034 Dispositivo contra push p/lavabo	\$ 150.19
					
SH-959	Paquete de rondanas para ensambles TS	\$ 31.51		SH-1045 Cartucho para monomando de lavabo	\$ 278.02
SH-972	Tapón c/O'ring maneral	\$ 86.01			
SH-972-L	Tapón c/O'ring maneral laca	\$ 94.57			
SH-972-S	Tapón c/O'ring maneral satin	\$ 94.57			
	SH-973 Maneral para monomando Nuva E-99 y E-32	\$ 1,139.91	SH-1047	Maneral armado Aqua	\$ 795.39
			SH-1053	Cuerpo lateral armado izq. valvex V	\$ 1,020.17
	SH-978 Valvex izquierdo para mezcladora Vértika cierre disco cerámico	\$ 457.31	SH-1054	Cuerpo lateral armado der. valvex V	\$ 1,020.17
				SH-1057 Cartucho monomando lavabo ecológico barreno frontal	\$ 813.48
	SH-979 Valvex derecho para mez. Vértika	\$ 457.31			
			SH-1062	Maneral armado p/mon. lav. Explora	\$ 1,041.27
			SH-1063	Maneral armado p/mon. lav. Vértika	\$ 912.12
			SH-1063-S	Maneral armado p/mon. lav. Vértika satin	\$ 1,048.91
			SH-1065	Maneral armado ch izq. p/lav. Primma	\$ 1,070.55
			SH-1067	Portacartucho arm. p/mon. lav. Vértika	\$ 1,130.77
			SH-1069	Maneral arm. p/mon. lav. Acueducto	\$ 621.08
	SH-985 Chapetón cobre taladro para fregadero	\$ 651.53	SH-1070	Chapetón c/emp. p/mon. lav. Acueducto	\$ 990.38
				SH-1073 Extensión p/vástago arm. p/ valvex V	\$ 298.51
SH-985-S	Chapetón cobre taladro p/fregadero satin	\$ 716.69			

LLAVES Y MEZCLADORAS

Modelo	Descripción	Precio	Modelo	Descripción	Precio
 SH-1075	Manguera retráctil. p/mon. freg. E-305	\$ 1,275.88	 SH-1143	Aireador rectangular PL-RC 32x 8 IT 02.3280.0	\$ 403.90
SH-1080	Cúpula armada p/contra tipo hongo	\$ 863.93	 SH-1154	Cartucho armado 25 mm con vastago metalico	\$ 474.81
SH-1087	Botón armado p/maneral Premier	\$ 74.36	 SH-1168	Porta cartucho arm. p/mon. lav. Vértika	\$ 843.38
 SH-1091	Kit 5 pzas. aireador Spray 1.9 Lts/Min	\$ 802.64	 SH-1187	Chapetón armado p/mon. de lavabo	\$ 152.56
 SH-1093	Reg. manual p/monomando E-306	\$ 1,201.28	SH-1195	Maneral arm. p/mon. de pared E-3011	\$ 551.09
 SH-1112	Aireador oculto para monomando de lavabo E-909	\$ 120.87	SH-1200	Salida armada para fregadero	\$ 1,614.58
 SH-1114	Valvex V grande izquierdo cierre disco cerámico	\$ 340.00	SH-1201	Kit empaques p/salida de fregadero	\$ 21.92
 SH-1122	Aireador rectangular para monomando Vértika	\$ 424.88	 SH-1225	Cabezal magnético monomando E-307	\$ 1,412.95
SH-1123	Chapetón con empaques p/monomando	\$ 147.59	 SH-1251	Manguera metalica engargolada mon. E-307	\$ 1,432.88
SH-1128	Maneral armado p/mon. de freg. E-305 Cr	\$ 636.63	SH-1252	Ensamble palanca armada E-306	\$ 764.00
 SH-1131	Cartucho armado lavabo a pared 35 mm	\$ 648.28	 SH-1254	Aireador oculto para monomando slim	\$ 79.37
 SH-1134	Cartucho para monomando 25 mm	\$ 972.40	SH-1295	Man. arm. p/mezcladora mon.	\$ 793.63
 SH-1135	Aireador oculto M24 x 16G STD 2.2 GPM	\$ 134.33	SH-1297	Maneral p/mon. lavabo E-914 y E-915	\$ 606.02
			 SH-1308	Cartucho rotativo 28 mm. mon. Bamboo	\$ 462.39
			SH-1310	Varilla con botón armado larga	\$ 370.23
			SH-1310-S	Varilla con botón armado larga satin	\$ 425.75
			 SH-1324	Aireador rect. PLC-LC 32x1.5 GPM	\$ 482.08
			SH-1329	Aireador 6LPM Monomando E-923	\$ 79.37

LLAVES Y MEZCLADORAS

Modelo	Descripción	Precio
SH-1336	Man. arm. p/mezc. M-1005 y MR-1005	\$ 840.39
SH-1338	Chap. arm. p/mezcladora MR-1005	\$ 308.62
SH-1339	Chap. p/mezcladora MR-1005	\$ 132.27
 SH-1343	Valvex II-F chico izquierdo cierre disco cerámico	\$ 388.43
 SH-1344	Valvex II-F chico derecho	\$ 388.43
SH-1357	Economizador p/mon. a pared	\$ 53.04
SH-1359	Kit de sujeción p/mon. E-309	\$ 93.80
SH-1360	Tapon con O'ring mon. E-308	\$ 194.20
SH-1369	Kit de llaves de mantenimiento	\$ 1,591.57
 SH-1376	Kit de Valvex II-A derecho cerámico	\$ 729.42
 SH-1377	Kit de Valvex II-A izquierdo cerámico	\$ 729.42
SH-1387	Maneral arm. p/mon Vertika	\$ 417.98
SH-1390	Maneral armado p/mon. d acueducto	\$ 518.26
SH-1390-S	Maneral armado p/mon. d acueducto S	\$ 595.98
SH-1393	Kit de empaques p/mant. TH-148	\$ 228.28
SH-1397-S	Salida p. monomando de cocina E-300 S	\$ 2,094.75
SH-1402	Maneral armado p/mezcl M-1006	\$ 946.06
SH-1405	Maneral armado p/mon Vertika EP-905	\$ 439.85
SH-1406	Maneral armado p/mon Mantis	\$ 906.57
SH-1407	Maneral armado p/mon EP-909	\$ 735.47
SH-1408	Kit emp. de suj. p/mon E-905, EP-905, EP-909	\$ 44.06
SH-1409	Kit emp. de suj. p/mon MP-1000, EP-2120, 914, 915	\$ 42.76
SH-1410	Maneral armado p/mon. EP-914, EP-915	\$ 587.61
SH-1411	Maneral armado p/mon. EP-99	\$ 1,139.91
SH-1412	Botón armado p/maneral de monomando	\$ 30.75
SH-1413	Kit de llaves de mant. p/mon.	\$ 276.45
SH-1415	Maneral armado p/mon Elegance	\$ 643.19
SH-1416	Kit de emp. suj. p/mezcl MP-03, MPO3-1.9	\$ 53.22
SH-1417	Kit de emp. suj. EP-2114, EP2001-1.9	\$ 51.81
SH-1418	Kit de empaques sujeción EP-2115	\$ 36.99
SH-1420	Maneral arm. Albatros derecho	\$ 318.72
SH-1421	Maneral arm. Albatros izquierdo	\$ 318.72

Modelo	Descripción	Precio
 SH-1441	Aireador para cabezal magnético E-307	\$ 253.27
SH-1455	Kit contra rej y contra hongo lav s/reb	\$ 59.38
SH-1460	Aireador para salida electrónica 0.35 GPM	\$ 130.30
SH-1510	Maneral para monomando E-300	\$ 494.01
SH-1510-S	Maneral para monomando E-300 S	\$ 568.11
 SH-1541	Eje hexagonal armado E-300	\$ 135.36
SH-1558	Aireador slim tipo spray 3.8 L/M E-948	\$ 221.99
SH-1559	Tapón con empaque E-300	\$ 72.69
 SH-1569	Cartucho KX D 45 mm	\$ 504.92
SH-1592	Chapetón p/monomando E-306	\$ 180.65
 SH-1598	Cartucho rotativo 25 mm	\$ 634.02
 SH-1612	Cartucho D 35 mm Ex35 TOP TRN	\$ 430.44
SH-1624	Kit contra inserto rejillas rebosadero	\$ 40.92
SH-1625	Kit contra inserto push sin rebosadero	\$ 40.92
 SH-1632	Cabezal magnético E-312	\$ 1,568.35
SH-1644	Maneral p/monomando LUS-100	\$ 704.18
SH-1663	Cupula arm. p/contra tipo hongo TH062 063	\$ 407.57
SH-1691	Cúpula armada TH-062	\$ 407.57
 SB-1011	Kit 5 piezas aireador oculto 5.67 Lts/min	\$ 1,333.11
 SB-1012	Kit 5 piezas aireador lav. 8.31 L X min.	\$ 953.07
 SB-1012-S	Kit 5 piezas aireador lav. 8.31 L X min. satin	\$ 1,104.22
 SB-1013	Kit 5 piezas aireador lav. 8.31 L X min.	\$ 1,333.11
 SB-1014	Kit 5 piezas aireador lav. 5.67 L x min.	\$ 953.07
 SB-1014-S	Kit 5 piezas aireador lav. 5.67 L x min. satin	\$ 1,157.22

ACCESORIOS



Modelo	Descripción	Precio
--------	-------------	--------

RA-005	Jabonera sobreponer 101, 102 Clásica	\$ 50.27
---------------	---	----------



RA-009	Tornillo No. 8 x 1/4"	\$ 2.05
RA-014	Resorte para tubo portapapel	\$ 13.06
RA-016	Tubo interior portapapel 104	\$ 121.61
RA-017	Tubo exterior portapapel cromo	\$ 91.84

RA-021	Opresor No. 8 x 27/64"	\$ 4.64
---------------	------------------------	---------



RA-022	Tapón para toallero múltiple cromo	\$ 125.60
RA-022-S	Tapón para toallero múltiple satín	\$ 138.18
RA-024	Base Accesorio 106, 107, 108 Clásica cromo	\$ 197.94

RA-028	Jabonera transparente 108 Clásica	\$ 17.97
---------------	--------------------------------------	----------



Modelo	Descripción	Precio
--------	-------------	--------

RA-037	Unión para argolla	\$ 17.57
RA-039	Argolla p/toallero cuadrado 109 Clásica Cr	\$ 398.70
RA-041	Base accesorio 110-118 Clásica cromo	\$ 230.18
RA-042	Pija 10-16 tipo ABx2" cromo	\$ 21.11
RA-044	Tubo toallero 110 Clásica cromo	\$ 503.21
RA-046	Tornillo unión tubo toallero cromo solera	\$ 43.69
RA-047	Tornillo 8-32 UNC-2a x 3/8"	\$ 1.87
RA-076	Tornillo sujeción 1/4-20	\$ 70.69
RA-087	Barra toallero 105 Clásica cromo	\$ 558.97
RA-130	Ancla chapetón cromo	\$ 187.47
RA-220	Porta ancla base toallero	\$ 21.92
RA-253	Tornillo 1/4" x 20 UNC x 1.09" cromo	\$ 66.68
RA-301	Opresor 1/4-20 UNC-2a x 3/16"	\$ 23.81
RA-315	Jabonera para 102 Clásica cromo	\$ 387.14
RA-316	Tuerca No. 8-32 NC x 3/8"	\$ 10.64



RA-345	Resorte de compresión	\$ 13.06
---------------	-----------------------	----------





RA-400	Opresor No. 8 23/64	\$ 11.75
---------------	---------------------	----------





RA-437	Ancla para atornillar	\$ 18.61
---------------	-----------------------	----------

RA-534	Tapón toallero barra Antigua cromo	\$ 95.83
RA-534-S	Tapón toallero barra Antigua satín	\$ 105.42
RA-569	Soporte p/tubo portapapel cromo	\$ 128.73
RA-608	O'ring 2-119	\$ 5.09
RA-614	O'ring 2-133	\$ 5.81
RA-618	Empaque cepillera y jab. Nuva	\$ 40.08









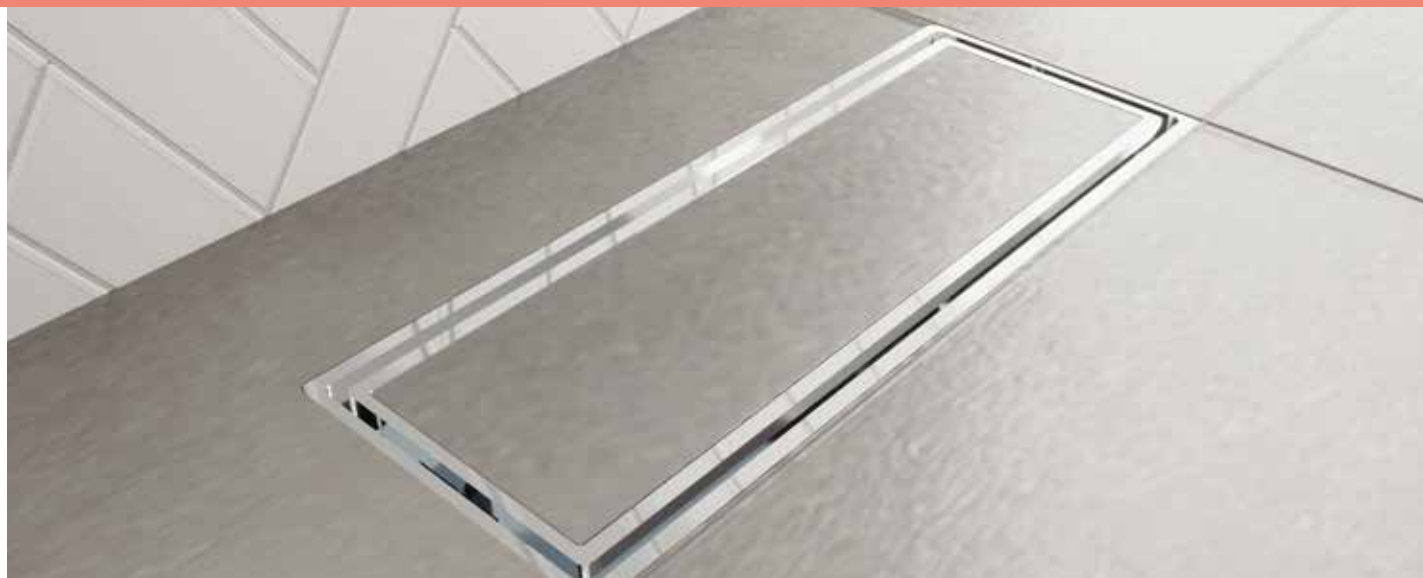

ACCESORIOS

Modelo	Descripción	Precio
 RA-619	Vaso cristal para cepillero Nuva	\$ 776.46
 RA-621	Cristal para jabonera sencilla Nuva	\$ 560.23
RA-633	Anillo para jabonera y cepillera cromo	\$ 616.22
RA-637	Tornillo allen 8-32 x 5/16"	\$ 10.64
RA-640	Opresor allen 10-24 UNC x 1/4"	\$ 8.14
RA-644	Barra para toallero Nuva cromo	\$ 1,124.14
RA-648	Opresor allen 10-24 UNC 2Ax5/16" AI	\$ 10.64
RA-650	Tornillo allen No. 24-24 x 1 1/2"	\$ 12.67
 RA-652	Ancla para accesorios Nuva	\$ 187.94
 RA-726	Jabonera sobreponer para 208 Clásica II	\$ 61.29
RA-735	Resorte portapapel 215	\$ 21.36
 RA-741	Ancla para accesorios Miura	\$ 118.49
RA-790	Tornillo allen 10-24 X 3-8"	\$ 9.50
RA-791	Llave allen 5/32"	\$ 29.93
RA-796	Opresor allen 8-32 x 1/2"	\$ 8.93
RA-829	Tornillo p/lav. 5-40 X 0.45 logitud	\$ 2.64



Modelo	Descripción	Precio
 RA-867	Vaso cepillero de cristal Innovex	\$ 246.49
RA-919-AI	Opresor allen 10-24 UNC AI	\$ 2.62
RA-990	Ancla para accesorios	\$ 97.24
RA-1013	Opresor 8-32 UNC x 3/8	\$ 3.83
RA-1051	Base soporte para accesorios Nuva cromo	\$ 216.66
RA-1052	Soporte p/accesorio Nuva	\$ 578.74
RA-1063	Tornillo autorroscable 8-32	\$ 7.28
RA-1066	Ancla p/ accesorios y reg. manual Vértika	\$ 118.49
RA-1095	Ancla p/accesorios Magna	\$ 119.67
RA-1154	Ancla para accesorio Explora	\$ 21.36
RA-1197	Ancla para accesorio	\$ 133.21
RA-1208	Tornillo especial 1/4" -20 UNC x 0.450"	\$ 63.45
SA-021	 Tubo portapapel armado cromo	\$ 192.32
SA-021-L	Tubo portapapel armado laca	\$ 244.46
SA-021-S	Tubo portapapel armado satin	\$ 230.79
SA-080	Tubo portapapel antirrobo armado cromo	\$ 431.84
SA-119	Taq. plast-6 ancla y pija 10-16 x 1"	\$ 43.45
SA-120	Taq. plomo-3 y pija 10-16-AB x 2"	\$ 90.05
SA-124	Taquete plomo -3 y pija 10-16	\$ 61.90
SA-125	Paquete de pijas c/ taquetes barra seg.	\$ 117.17
SA-172	Paquete de pijas con taquetes	\$ 55.03
SA-223	Juego de taquetes con pijas 10-16x1"	\$ 14.23
SA-225	Soporte c/chap. izquierdo Nuva cromo	\$ 1,089.88

COLADERAS



Modelo	Descripción	Precio	Modelo	Descripción	Precio
RC-002	Anillo para coladera 444 y 444X	\$ 139.99	 RC-020	Rejilla contra coladera 24, 25, 26, 342	\$ 149.42
RC-003	Tornillo colad. 444, 446, 4954 y 2514	\$ 4.88			
RC-006	Anillo para coladera 446X	\$ 405.50			
RC-008	Canasta para base coladera 5424	\$ 608.62			
RC-009	Rejilla canasta coladera 5424	\$ 264.35	 RC-024	Casquillo para coladera 27 y 28	\$ 105.47
RC-010	Contra rejilla coladera 262	\$ 925.61			
 RC-011	Rejilla de contra 262-H, 282-H, 1342-H	\$ 322.94	RC-026	Campana base coladera 2514, 2584	\$ 503.03
			RC-027	Rejilla coladera 2514	\$ 376.78
 RC-012	Tornillo niquelado No. 10	\$ 4.88	RC-028	Rondana de presión 3/8"	\$ 1.26
			RC-030	Rejilla rectangular 2714	\$ 876.45
 RC-014	Contra rejilla cuadrada	\$ 1,722.57	 RC-032	Casquillo contra chica 24	\$ 63.71
 RC-016	Casquillo contra grande 282-H	\$ 144.64	 RC-033	Tapa ciega coladera 26	\$ 147.51
 RC-018	Tapa ciega coladera 282-H, 1342-H	\$ 222.91	RC-034	Campana para coladera 2714	\$ 503.03
			 RC-037	Rej. cuad. 1342, 282 acero inoxidable	\$ 347.13
 RC-019	Contra rejilla coladera 24, 25, 26, 342	\$ 578.56	RC-042	Marco angular base 4954	\$ 326.22
			RC-043	Rejilla para coladera 4954	\$ 297.56
			RC-048	Rejilla coladera 2584 20 x 20	\$ 1,410.36

COLADERAS

Modelo	Descripción	Precio	Modelo	Descripción	Precio
 RC-054	Tornillo cab. plana No. 8-32 UNC x3-8"	\$ 4.88	RC-110	Cúpula p/contra coladera cuad. gde. lisa	\$ 502.59
 RC-062	Rejilla contra coladera 632-H	\$ 721.81	RC-111	Casquillo grande para coladera lisa	\$ 41.67
RC-066	Empaque tapa exterior válvula 1176	\$ 72.36	RC-112	Inserto para coladera grande	\$ 353.90
RC-068	Brazo tapa interior válvula 1176	\$ 339.58	RC-115	Llave para coladera lisa	\$ 31.85
RC-069	Columpio válvula 1176	\$ 123.39	RC-134	Tapa ciega cuadrada coladera 24 y 25-CH	\$ 156.41
RC-072	Tapa interior válvula 1176	\$ 1,137.84	RC-142	Contra redonda chica 25-HLI	\$ 458.01
 RC-073	Cúpula de coladera 444 y 444-X	\$ 461.49	RC-143	Cúpula redonda chica 24 y 25-HLI	\$ 332.69
RC-074	Rejilla cuadrada ciega	\$ 332.24	RC-148	Cúpula p/rebosadero lisa red y cuad/chic	\$ 353.82
 RC-078	Cúpula de coladera 446-X	\$ 978.67	RC-154	Llave p/mantenimiento 24 y 25-HLI	\$ 85.77
 RC-098	Contra rejilla cuadrada 24, 25-CH y 24-CH	\$ 737.90	RC-161	Contra coladera perimetral Chica	\$ 453.73
 RC-100	Rejilla cuadrada 24-25-CH Ac. Inox.	\$ 149.42	 RC-162	Porta inserto cuadrado chico	\$ 423.88
RC-103	Contra coladera Red 24HL y 25HL	\$ 289.19	RC-164	Contra coladera perimetral GDE	\$ 1,129.58
 RC-104	Cúpula p/contra coladera lisa chica	\$ 372.45	SC-002	Marco y soporte soldado col. 2584	\$ 1,646.07
RC-105	Inserto p/coladera redonda lisa chica	\$ 159.09	 SC-007	Rejilla con campana armada	\$ 887.13
 RC-106	Casquillo chico p/ coladera lisa redonda	\$ 43.96	SC-008	Kit para coladera 2584	\$ 3,086.21
			 SC-011	Rejilla col. 282-1342 c/ casquillo	\$ 1,463.57
			SC-012	Rej. ciega c/casquillo p/coladera 282-1342	\$ 1,323.83
			 SC-016	Rejilla para coladera 24 y 25 c/casquillo	\$ 834.62
			SC-020	Rej. ciega para coladera 26 c/casquillo	\$ 832.80
			 SC-021	Contra armada redonda lisa chica	\$ 949.63
			SC-022	Contra armada cuadrada lisa chica	\$ 1,214.24
			SC-023	Contra armada redonda lisa grande	\$ 1,870.71
			SC-024	Rejilla para coladera 27 y 28 con casquillo	\$ 886.33
			SC-025	Contra armada cuadrada lisa grande	\$ 1,665.49
			SC-028	Rejilla a. Inox. c/casq. p/coladera 1342-35 CH	\$ 2,232.23
			SC-035	Rejilla p coladera cuadrada con casquillo	\$ 874.42

COLADERAS

Modelo	Descripción	Precio
 SC-036	Contra armada p/ coladera 24-HLI	\$ 993.76
SC-037	Contra arm. redonda p/coladera 282-HLI	\$ 1,870.71
 SC-040	Contra arm. cuad. p/ coladera 24 y 25-CHLI	\$ 1,043.90
SC-041	Ctra. arm. cuad. p/coladera 1342 y 282 CHLI	\$ 2,289.33
SC-042	Porta inserto cuadro chico c/tornillo	\$ 581.03
SC-043	Porta inserto cuadro gde. c/tornillo	\$ 1,044.87
 SC-049	Contra armada para coladera 24-RHLI	\$ 3,417.14
SC-055	Porta inserto Rect c/ tornillo soporte	\$ 1,725.60
SC-057	Porta inserto 24-RHLI	\$ 1,196.66
SC-058	Contra coladera 24-RHLI 30cm	\$ 1,936.78
SC-063	Rejilla redonda PE-18-41 342CL	\$ 233.54
 SC-064	Contra armada para coladera 24-RHLI-60	\$ 4,112.56
SC-066	Contra armada para coladera 24-RHLI-90	\$ 7,674.42
 SC-075	Contra rejilla cuadrada 1 boca AIBR 22-CH	\$ 1,442.49
 SC-076	Contra cont. cuadrada 1 Boca 22-CHL, 22-CHL CR	\$ 1,591.10
 SC-077	Contra p/inserto cuadrada 1 Boca 22 CHLI, 22V CHLI CR	\$ 617.36
 SC-078	Contra de contor. red 1 Boca 22-HL, 22V HL	\$ 851.50

Modelo	Descripción	Precio
 SC-079	Contra inser 1 Boca 22HLI, 22V HLI CR	\$ 1,104.89
 RC-240	Vaso coladera 22	\$ 52.71
 RC-241	Embudo para coladera 22	\$ 26.22
 RC-252	Tornillo cónico 8-32 unc x 3/8"	\$ 22.61
 RC-253	Soporte para cúpula coladera 22	\$ 198.26

VÁLVULAS Y VARIOS



Modelo	Descripción	Precio
RV-008	O'ring 2-214	\$ 6.47
RV-056	O'ring 2-015	\$ 3.32
 RV-071	Rondana para espárrago hule	\$ 12.82
RV-072	Rondana para espárrago latón	\$ 21.98
RV-086	O'ring 2-124	\$ 9.69
 RV-089	Rondana hule tapón céspol	\$ 7.16
RV-090	Tapón céspol lavabo	\$ 102.42
RV-091	Tuerca cuerpo y codo céspol	\$ 252.62
RV-092	Codo para céspol lavabo	\$ 527.25
 RV-093	O'ring 2-218	\$ 16.81
RV-094	Chapetón para céspol lavabo	\$ 131.46
RV-105	Tuerca hexagonal 3/4-14	\$ 70.34
RV-126	Tornillo 3/8" cabeza plana ranurada -16 UN	\$ 12.26
 RV-130	Resorte cónico economizadora	\$ 12.26
RV-163	O'ring 2-008	\$ 2.58

Modelo	Descripción	Precio
 RV-215	O'ring 2-109	\$ 2.58
RV-225	Opresor allen 5/32"	\$ 14.02
 RV-249	Rejilla salida de tina Elite	\$ 36.66
 RV-259	Sello para llave economizadora	\$ 17.35
 RV-262	Separador boquilla para economizadora	\$ 7.76
 RV-263	Filtro llave economizadora	\$ 12.26
 RV-268	Empaque para boquilla economizadora	\$ 5.09
RV-279	Barril protector economizadora	\$ 45.10

VÁLVULAS Y VARIOS

Modelo	Descripción	Precio
	RV-280 Boquilla economizadora	\$ 108.95
RV-283	Empaque neopreno economizadora	\$ 13.99
RV-284	Seguro barril economizadora	\$ 2.58
RV-331	O'ring 2-013	\$ 5.09
RV-386	Espárrago salida Alfa II	\$ 76.72
RV-399	Tornillo m-4 x 29/64"	\$ 4.63
RV-401	Porta cartucho mon. para regadera	\$ 292.87
RV-431	Llave allen 5/64"	\$ 17.72
RV-456	Llave allen 3/32	\$ 29.84
RV-551	Filtro p/valv check p/sal	\$ 52.06
RV-554	Vastago valv push	\$ 36.51
RV-618	Tuerca espaciadora	\$ 54.89
	RV-660 Pila de litio CR-P2 6V para fluxómetros y llaves	\$ 301.41
	RV-668 Espárrago salida electrónica	\$ 157.30
	RV-713 Rondana acero inoxidable	\$ 5.22
RV-727	Tornillo 10-2A-UNC-2A CR	\$ 19.99
RV-727-S	Tornillo 10-2A-UNC-2A satin	\$ 22.01
	RV-729 Casquillo para cartucho	\$ 32.50
RV-732	Extensión maneral monomando CR	\$ 178.67
RV-732-S	Extensión maneral monomando satin	\$ 223.30
RV-733	Buje para maneral monomando CR	\$ 119.34
RV-733-S	Buje para maneral monomando satin	\$ 149.25
RV-740	O'ring 2-028	\$ 7.34
RV-742	Llave allen 2 mm	\$ 20.71
RV-760	Tapón salida de tina Elite	\$ 173.30
RV-763	O'ring 2-023	\$ 11.73
RV-774	Tubo trampa céspol TV-017 CR	\$ 181.66
RV-776	Empaque sello tubo céspol TV-017	\$ 8.72
RV-777	Tapa de servicio céspol Nuva CR	\$ 379.25
RV-778	Chapetón tubo desagüe CR	\$ 204.32
RV-779	Tubo desagüe para céspol CR	\$ 534.98
RV-780	Porta sensor para salidas electrónicas	\$ 41.30
RV-782	Filtro para electroválvula	\$ 33.96

Modelo	Descripción	Precio
RV-788	Cable toma corriente	\$ 114.64
RV-792	O'ring 2-030	\$ 14.93
RV-796	Base de electroválvula para clip	\$ 87.14
RV-798	Empaque base para salida	\$ 21.94
RV-810	Empaque sello tapa céspol	\$ 22.41
RV-825	Resorte de compresión push	\$ 22.62
RV-827	Empaque para TV-120	\$ 12.32
RV-828	Inserto central valvula de push	\$ 11.92
RV-829	Vaso de válvula push	\$ 44.89
RV-830	Vastago central para push	\$ 8.82
RV-833	O'Ring 6-685	\$ 9.50
RV-834	Empaque cónico inferior para TV-120	\$ 11.83
RV-835	Resorte cónico para cartucho TV-120	\$ 47.42
RV-838	Arillo regulador p/cartucho TV-120-CR	\$ 154.25
RV-841	Separador cuerpo central de Sahaoprene	\$ 51.75
RV-844	Rondana para céspol TV-017	\$ 13.11
RV-855	Empaque para salida electrónica	\$ 25.09
RV-865	O'ring 2-130	\$ 11.46
RV-886	Reductor de velocidad p/ IG-40	\$ 1,121.75
RV-937	Rompe chorros salida de tina	\$ 18.98
RV-952	Conector p/salida de tina a pared 3/4"	\$ 235.86
RV-961	Opresor allen Al 1/4" 20x 5/8"	\$ 9.38
RV-1027	O'ring 2-202	\$ 6.41
RV-1225	Sello de perfil blando para IG-20	\$ 398.68

	RV-1255 Tornillo p/IG-20 de 1/2" "-13 UNC ALL	\$ 57.13
---	--	----------

RV-1277	Empaque Cónico para push	\$ 12.21
RV-1283	O'ring 2-222	\$ 8.83
RV-1300	Inserto para mon. regadera plástico	\$ 3.83
RV-1306	Botón desviador p/mon. reg. CR	\$ 158.03
RV-1306-S	Botón desviador p/mon. reg. satin	\$ 181.73
RV-1315	Tubo extensión p/tarja doble	\$ 157.86
RV-1320	Empaque para céspol tarja	\$ 15.39
RV-1350	Botón cuadrado p/desviador mon. reg. CR	\$ 378.91
RV-1350-S	Botón cuadrado p/desv. mon. reg. satin	\$ 435.77
RV-1404	Empaque p/chapetón mon. reg. Magna	\$ 7.66
RV-1407	Buje antifricción p/mon. reg. Nuva	\$ 6.32
RV-1409	Buje antifricción p/ monomando CR.	\$ 3.20
RV-1445	Soporte p/sensor sal. elec. lav. TV-200 Nuva	\$ 114.67
RV-1446	Chapetón para sensor TV-200 CR	\$ 319.29
RV-1469	Portacartucho p/monom. reg. Vértika	\$ 301.33
RV-1471	Esfera manija monom. reg E-700 Vértika	\$ 86.01
RV-1471-S	Esfera manija monom. reg E-700 Vértika-S	\$ 98.90
RV-1472	Chapetón redondo p/mom reg. E-700 Vértika CR	\$ 178.41
RV-1472-S	Chapetón red. p/mon reg. E-700 Vértika-S	\$ 205.18
RV-1473	Rondana antifricción p/chapetón redondo	\$ 17.25
RV-1474	Tuerca port. cart.mon.reg. Vértika-Premier	\$ 104.90
RV-1476	Manija p/monom. reg. E-700 Vértika CR.	\$ 447.16

VÁLVULAS Y VARIOS

Modelo	Descripción	Precio
RV-1476-S	Manija p/mon. reg. E-700 Vértika-S	\$ 513.73
RV-1479	Tuerca sup. p/mon. reg. Vértika-Premier	\$ 153.61
RV-1480	SopORTE p/chapeton mon reg E-700 Vértika	\$ 88.71
RV-1486	Llave p/tuerca cartucho mon. reg. Vértika	\$ 47.95
RV-1555	Inserto p/salidas lavabo electrónica	\$ 125.21
RV-1558	Palanca p/monomando reg. tina Premier CR	\$ 486.98
RV-1558-S	Palanca p/mon. reg. tina Premier S	\$ 560.02
RV-1573	Tuerca espárrago p/salida capacitiva	\$ 53.48
RV-1576	Espárrago salida capacitiva TV-190	\$ 52.39
RV-1578	Espárrago de sujeción para salida	\$ 76.43
RV-1616	Conector para Valvex Check	\$ 86.98
RV-1622	Sello de perfil blando IG-20 PTM	\$ 398.68
RV-1662	Base llave economizadora a pared	\$ 236.64
RV-1663	Tuerca porta filtro	\$ 101.41
RV-1664	Vástago porta filtro	\$ 218.10
RV-1682	Opresor 8-32 UNC 2A X 0.18	\$ 8.78
RV-1691	Empaque amortiguador p/mon. regadera	\$ 12.44
RV-1701	Niple salida economizadora	\$ 165.91

 **RV-1809** Codo p/cespol de 40 cm p/TV-016 \$ 484.04

RV-1917 Empaque sello para cartucho BP \$ 47.27

 **RV-1966** Pila alcalina AA p/salidas electrónicas \$ 32.14
RV-2133 Camisa porta cartucho \$ 478.91
RV-2134 Extensión porta cartucho \$ 466.42

SV-006 Cuerpo central con niple \$ 326.51

SV-052 Mang. flex B4F20" \$ 227.13

SV-062 Palanca y perilla economiz. CR \$ 103.80

Kit para salida economizadora \$ 332.12

SV-064

RA-345	Resorte de compresión
RV-130	Resorte cónico
RV-259	Sello lat. sal. e.
RV-262	Separador sal. e.
RV-263	Filtro sal. econom.
RV-268	Emp. boq. sal. e.
RV-279	Barril protec. sal. e.
RV-280	Boquilla 7/8 sal. e.
RV-284	Seguro p/barril e.
SV-062	Palanca y perilla llave econom.

SV-071 Cubre tornillos con sello CR \$ 239.22

 **SV-072** Chapeton con sello adhesivo CR \$ 602.65

Modelo	Descripción	Precio
SV-191	Paquete pijas taquetes	\$ 28.27
SV-239	Chapeton con sello adhesivo 8" CR	\$ 1,079.58
SV-262-K	Kit Cartucho monomando 40 mm BP	\$ 1,225.62
SV-290	Paq. de torno p/chapeton mon. de reg.	\$ 31.56
SV-290-N	Paquete tornillos p/chapeton mon. reg. N	\$ 31.45
SV-290-S	Paquete tornillos p/chapeton mon. reg. S	\$ 36.18
SV-326	Chapeton para monom. E-762 CR	\$ 1,252.67
SV-329	Juego de tornillos M5 X 0.8 CR	\$ 81.01
SV-329-S	Juego de tornillos M5X0.8 S	\$ 93.18

 **SV-335** Maneral mon. reg. Nuva armado CR \$ 1,348.53

SV-336 Chapeton oval c/empaque CR \$ 1,212.98

SV-336-S Chapeton oval c/empaque satin \$ 1,334.30

SV-337 Chap. mon. Nuva E-47, E-771 c/emp. CR \$ 911.63

SV-337-S Chap. mon. Nuva E-47, E-771 satin c/emp. \$ 1,002.82

SV-339 Chap.c/empaque mon. reg. Nuva PVD CR \$ 1,212.98

SV-339-S Chapeton oval c/empaque c/desviador satin \$ 1,334.39

SV-348 Cartucho economizador cierre automático TV-120 CR \$ 837.20

SV-348-S Cartucho economizador cierre automático TV-120 Satin \$ 921.28

 **SV-358** Sensor para lavamanos C1016 LM \$ 2,714.48

 **SV-359** Electroválvula 6V-1/2" nueva \$ 1,194.06

 **SV-360** Fuente de alimentación 115-230 Vac 6VDC \$ 2,340.98

VÁLVULAS Y VARIOS

Modelo	Descripción	Precio
SV-361	Manguera de 1/2"-1/4" 12 Longitud	\$ 181.26
 SV-362	Porta pilas nuevo	\$ 556.25
 SV-365	Cartucho para monomando regadera	\$ 722.27
SV-371	Chapetón para monomando	\$ 1,252.67
SV-382	Mampara soldada 2 p/interceptor IG-40	\$ 1,265.57
SV-383	Mampara soldada 3 p/interceptor IG-40	\$ 1,081.50
SV-386	Tapa con cerradura para IG-40	\$ 7,513.27
SV-390	Mampara soldada chica interc. IG-20	\$ 361.63
SV-391	Mampara soldada grande interc. IG-20	\$ 516.59
SV-392	Placa desviadora soldada interc. IG-20	\$ 462.90
SV-395	Tapa para caja interceptor de grasa	\$ 6,022.49
 SV-409	Cartucho monomando 40 mm BP	\$ 1,205.23
 SV-409-S	Cartucho monomando 40 mm BP	\$ 1,205.23
SV-421	Espárrago conector arm. p/salida de tina	\$ 948.24
SV-444	Canasta c/agarradera para IG-40	\$ 2,681.12
SV-446	Canasta c/agarradera para IG-20	\$ 1,775.07
 SV-454	Economizador para TV-105	\$ 93.91
SV-486	Tapa interceptora de grasa IG-20	\$ 3,375.52
 SV-487	Manguera Flexible de 1/2" NPSM 12"	\$ 210.31

Modelo	Descripción	Precio
 SV-492	Módulo electrónico capacitivo	\$ 4,725.58
 SV-504	Válvula check p/salida econ. push TV-120	\$ 243.12
 SV-515	Sensor p/lav. a pared longitud 120 cm	\$ 3,304.85
SV-517	Maneral para monomando Kúbica II CR	\$ 1,452.16
SV-517-S	Maneral para monomando Kúbica II satin	\$ 1,669.96
 SV-520	Desviador armado para mon. regadera CR	\$ 816.35
SV-520-S	Desviador arm. p/ mon. d/regad. S	\$ 907.09
 SV-521	Kit reparación c/empaques p/desv. cpo. reg.	\$ 22.10
SV-531	Chapetón con empaque p/mon. reg. Vértika	\$ 942.47
SV-531-S	Chap. con empaque p/mon. reg. Vértika satin	\$ 1,083.82
 SV-539	Maneral armado p/mon. reg. Explora CR	\$ 977.62
SV-540	Cartucho p/salida tina Innovex	\$ 455.87
SV-541	Desviador arm. p/mon. reg botón cuad.	\$ 1,415.08
 SV-542	Chapetón con empaque p/mon. reg. Explora CR	\$ 554.67
SV-546	Chapetón con empaq. mon. reg. c/desv. Explor	\$ 571.18
SV-551	Aireador tipo spray 0.5 GPM	\$ 171.58
SV-554	Chapetón c/empaque p/mon. regadera desv.	\$ 1,307.45
SV-554-S	Chapetón c/empaque p/mon. regadera desv.	\$ 1,503.57

VÁLVULAS Y VARIOS

Modelo	Descripción	Precio
 SV-558	Maneral armado para monomando reg. Novus CR	\$ 691.41
 SV-559	Maneral armado para monomando reg. Aqua Cr	\$ 967.92
SV-559-S	Maneral armado p/mon. reg. Aqua satín	\$ 1,113.11
SV-560	Maneral armado p/mon. reg. Magna Cr	\$ 1,158.50
SV-561	Maneral armado p/mon. lavabo Nuva Cr	\$ 655.06
SV-561-S	Maneral armado p/mon. lavabo Nuva Satín	\$ 753.33
SV-567	Chapetón c/empa. p/mon. reg. E-702 Premier Cr	\$ 579.41
SV-567-S	Chapetón c/empaques p/mon. regadera S.	\$ 637.34
 SV-575	Desv. armado p/mon. reg. botón cuad. Cr	\$ 1,360.17
SV-577	Chapetón c/empaques p/monom. de lav.	\$ 579.41
SV-590	Aireador oculto HC STD m24x1	\$ 92.70
 SV-604	Aireador spray oculto 0.5 GPM.	\$ 226.39
 SV-605	Aireador spray oculto 0.5 GPM. m 24x1	\$ 226.39
SV-612	Chapetón armado p/mon. de regadera	\$ 208.09
 SV-632	Vástago válvula push con O'ring	\$ 90.40
 SV-633	Kit de empaques para válvula push	\$ 71.42
 SV-645	Cartucho 40 mm mon. Barreno pasado	\$ 862.29
SV-651	Maneral redondo para regadera	\$ 538.03
SV-653	Maneral cuadrado mon/reg E-710	\$ 571.82
SV-660	Aumento p/porta cartucho VBP mon. sol	\$ 21.94
SV-685	Desviador para mon. de reg. cromo	\$ 888.84
SV-686	Boton desviador PIU 201 Cr	\$ 398.27
SV-687	Kit de empaques p/desviador mon. reg.	\$ 70.15
SV-688	Porta cartucho c/O'ring 40mm. mon. reg.	\$ 371.36
SV-688-S	Porta cartucho c/O'ring 40mm. mon. reg. S.	\$ 427.07
SV-689	Kit boton válvula temporizadora de reg. temporizadora de reg.	\$ 890.87

Modelo	Descripción	Precio
SV-696	Paquete de sujeción salida push TV-120	\$ 86.57
SV-726	Chapeton armado monomando E-713	\$ 719.32
 SV-731	Porta pilas p/salidas electrónicas	\$ 336.96
SV-754	Chapeton tapa armado mon. E-713	\$ 178.62
SV-755	Maneral maxima 40 mm E-713	\$ 836.08
SV-756	Kit de llaves de mantenimiento E-713	\$ 144.70
SV-757	Chapeton tapa armado mon. E-712	\$ 227.80
SV-758	Maneral maxima 40 mm. E-712	\$ 836.08
SV-759	Kit de llaves de mantenimiento E-712	\$ 144.70
SV-764	Kit sal economiz TV-106	\$ 332.72
SV-765	Chapeton s/barr portacartucho Gde. E781	\$ 1,584.30
SV-766	Caja armada para componentes electrónico	\$ 248.33
SV-767	Ensamble palanca economizadora TV-106	\$ 337.54
 SV-790	Cartucho KX D 40 mm	\$ 451.14
 SV-798	Cartucho de 35 mm	\$ 471.97
 SV-806	Cartucho de 35 mm	\$ 417.22
SV-860	Cartucho de 40 mm p/ mon. Nuva y Máxima	\$ 317.12
SV-861	Cartucho de 40 mm p/ mon. Premier y Piura	\$ 317.12
SV-869	Aireador para la TV-122-1.9	\$ 117.58
SV-886	Maneral armado PIA-200	\$ 586.75
SV-888	Maneral armado E-72	\$ 961.54
SV-889	Maneral armado E-77	\$ 851.99
SV-902	Maneral armado E-48	\$ 896.00
SV-903	Maneral armado E-59	\$ 756.40
SV-904	Maneral armado E-708	\$ 835.10
SV-914	Maneral armado E-709	\$ 991.81
SV-915	Maneral armado E-705	\$ 911.61
SV-916	Desviador armado PIU-201	\$ 690.78
SV-917	Desviador armado E-705	\$ 265.33
SV-918	Maneral armado E-700	\$ 475.60
SV-919	Desviador armado E-703	\$ 343.56
SV-920	Maneral armado E-713	\$ 836.08
SV-921	Maneral armado E-762	\$ 982.72
SV-922	Maneral armado E-84	\$ 1,118.27
SV-923	Maneral armado E-776	\$ 1,254.55

FLUXÓMETROS





Modelo	Descripción	Precio
--------	-------------	--------

	RF-003 Émbolo hembra para fluxómetro	\$ 261.26
--	---	-----------

	RF-005 Rondana hule émbolo hembra para fluxómetro	\$ 14.84
--	--	----------

	RF-015 Tornillo No. 8-32 UNC x 1/2	\$ 3.53
--	---	---------

	RF-016 Rondana neopreno cúpula fluxómetro	\$ 11.26
--	--	----------

	RF-018 O'ring 2-028	\$ 7.34
---	----------------------------	---------

	RF-024 Rondana hule para manija fluxómetro	\$ 23.23
---	---	----------

	RF-025 Empaque cónico para estopero de fluxómetro	\$ 22.43
--	--	----------

Modelo	Descripción	Precio
--------	-------------	--------

	RF-030 Resorte estopero para fluxómetro	\$ 18.43
---	--	----------

	RF-032-C Tuerca unión cople cuerpo principal cromo	\$ 147.82
--	---	-----------

RF-033	Rondana fibra NPL-EXT	\$ 11.79
---------------	-----------------------	----------

	RF-035 O'ring 2-123	\$ 8.89
---	----------------------------	---------



















	RF-036 Anillo presión NPL-EXT	\$ 26.00
---	--------------------------------------	----------

	RF-037-C Tuerca unión cople llave de retención cromo	\$ 151.37
---	---	-----------



















	RF-038-C Cuerpo llave retención 1" P Flux Cr	\$ 692.42
---	---	-----------

	RF-040 Guía delrin émbolo para fluxómetro	\$ 31.45
---	--	----------

FLUXÓMETROS

Modelo	Descripción	Precio	Modelo	Descripción	Precio
RF-041	Tornillo elevador llave retención s/cr	\$ 34.48	 RF-060	Rondana polietileno tuerca spud de 38 mm	\$ 5.97
 RF-041-C	Tornillo elevador p/ llave de retención cromo	\$ 45.10	RF-062	Tuerca spud 38 mm sin cromar	\$ 100.41
RF-042	Tuerca superior llave	\$ 138.92	 RF-062-C	Tuerca spud 38 mm cromo	\$ 160.39
 RF-042-C	Tuerca superior llave cromo	\$ 166.90	 RF-063	Tuerca F2-32 mm cromo	\$ 161.40
 RF-044	Rondana hule para tuerca F-2 de 32 mm	\$ 13.63	RF-068	Niple recto de 38x60 cromo	\$ 562.95
 RF-045	Rondana polietileno de 32 mm	\$ 7.16	 RF-070	Codo latón de 32 mm para flux. cromo	\$ 472.75
RF-047	Niple recto 32 mm p/flux. WC	\$ 122.36	 RF-072	Codo latón de 38 mm para flux. cromo	\$ 579.54
 RF-047-C	Niple recto 32 mm cromo p/ flux. WC	\$ 203.07	 RF-075	Rondana S-21 vulcanizada	\$ 67.09
 RF-048	Tuerca spud 32 mm	\$ 163.30	RF-076	Codo latón p/spud 38 mm 60 mm p/flux Cr	\$ 967.96
 RF-049	Rondana polietileno tuerca spud de 32 mm	\$ 5.97	 RF-080	Tuerca spud de 19 mm cromo	\$ 111.07
 RF-050	Rondana hule tuerca spud 32 mm y 38 mm	\$ 12.50	 RF-081	Rondana tuerca spud de 19 mm	\$ 11.26
 RF-052	Goma llantita S-14 vulcanizada	\$ 111.74	RF-096	Codo de latón de 19 x 90 fluxómetro	\$ 360.48
 RF-059-C	Niple recto de 38 mm cromo p/fluxómetro de WC Cr	\$ 255.92	 RF-104	Porta pedal fluxómetro	\$ 485.20

FLUXÓMETROS

Modelo	Descripción	Precio	Modelo	Descripción	Precio
 RF-105	Pedal para fluxómetro	\$ 255.39	 RF-247	Chapetón grande spud 32 mm cromo	\$ 165.65
 RF-106	Prisionero para pedal fluxómetro	\$ 22.56	RF-248	Chapetón chico de 32 mm llave reten. Cr	\$ 161.40
 RF-107	Botón para fluxómetro	\$ 113.94	 RF-249	Chapetón chico de 19 mm mingitorio	\$ 163.30
RF-108	Niple extensión para fluxómetro cromo	\$ 237.54	 RF-250	Émbolo llave retención	\$ 36.82
 RF-109	Tuerca cople para fluxómetro 6 lts.	\$ 144.86	 RF-256	Inserto émbolo llave de retención para fluxómetro	\$ 41.53
RF-110	Cuerpo llave retención p/fluxómetro	\$ 901.88	 RF-278	Chapetón spud 38 mm	\$ 165.11
RF-111	Codo latón de 32 mm fluxóm. de pedal	\$ 502.99	 RF-292	Manija recta para fluxómetro	\$ 202.56
RF-112	Niple de 32 mm fluxóm. pedal p/WC	\$ 521.00	RF-294	Rondana de latón 3 lts	\$ 129.51
RF-118	Base pedal fluxómetro	\$ 659.09	 RF-295	Rondana de latón 6 lts	\$ 129.51
 RF-120	O'ring 2-006 para perno estopero	\$ 4.32	RF-300	Perno asiento flux.pilas y corriente Nk	\$ 100.83
RF-124	Niple p/cuerno tall piece fluxómetro	\$ 267.14	 RF-309	Émbolo macho delrin 6 lts	\$ 75.69
 RF-223	O'ring 2-110	\$ 2.97	RF-325	Émbolo macho fluxómetro 3 lts.	\$ 69.41
 RF-230	Cuerpo estopero con cuerda fluxómetro	\$ 137.20	RF-336	Cpo. estopero fluxómetro electrónico Nk	\$ 165.65
 RF-232	Émbolo hembra 6 lts. electrónico	\$ 298.51	 RF-338	Resorte perno fluxómetro electrónico	\$ 5.37
RF-233	Émbolo hembra 3 lts. p/flux electrónicos	\$ 303.98	RF-339	Tuerca perno fluxómetro electrónico	\$ 64.81
 RF-234	Resorte émbolo llave retención	\$ 11.26	RF-340	Arandela goma llantita	\$ 10.06

FLUXÓMETROS

Modelo	Descripción	Precio
 RF-341	Goma llantita fluxómetro electrónico	\$ 16.43
 RF-344	O'ring 2-025	\$ 4.74
 RF-494	Filtro para fluxómetro de pila	\$ 147.01
RF-496	Cople externo con alojamiento	\$ 213.92
 RF-497	Cople int. p/ flux. bat NK	\$ 250.37
RF-519	Resorte de compresión p/botón de flux.	\$ 10.56
RF-521	Botón manual p/flux. electrónico Cr	\$ 169.33
 RF-523	Perno para fluxómetro	\$ 67.44
RF-525	Tornillo Allen 5-40 x 1/4"	\$ 45.05
RF-530	O'ring 2-116	\$ 9.54
RF-532	Tornillo para carcasa	\$ 48.00
RF-546	Botón para llave de retención	\$ 27.62
RF-547	tubo camisa para fluxómetros de 5"	\$ 256.93
RF-550	Caja p/ circuito eléctrico de fluxómetro	\$ 233.21
RF-551	Tapa circuito electrónico sin sensor	\$ 263.13
RF-552	Tornillo 8-32 x 1 1/4"	\$ 7.12
 RF-554	Porta electroválvula	\$ 645.12
RF-555	Porta sensor	\$ 13.36
RF-560	Llave plana para fluxómetros	\$ 77.13
RF-569	Cúpula llave de retención	\$ 296.25
RF-570	Cúpula p/flux Nuva Cr	\$ 513.04
RF-576	Inserto base fluxómetro	\$ 376.84
RF-583	Tuerca base	\$ 367.37
RF-584	Tuerca base fluxómetro	\$ 427.81
RF-586	Tuerca unión flux. spud 38	\$ 407.66
RF-590	Tuerca spud 32 mm p/fluxómetro 410-32	\$ 243.46
RF-591	Rondana para cúpula fluxómetro	\$ 44.56

















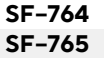



Modelo	Descripción	Precio
RF-614	Chapetón para fluxómetros cromo	\$ 92.43
RF-616	O'ring 2-132	\$ 5.71
RF-617	O'ring 2-122	\$ 4.48
RF-619	O'ring 2-20	\$ 3.09
RF-623	Manija recta para fluómetro 210	\$ 403.09
RF-630	Empaque sello fluxómetro	\$ 12.32
RF-631	Tuerca unión cople para cuerpo principal	\$ 181.91
RF-634	Tuerca unión fluxómetro	\$ 306.24
RF-636	Adaptador Budnik	\$ 251.53
 RF-637	Empaque p/llave de retención	\$ 20.56
RF-662	Tapón p/fluxómetro de doble botón Cr	\$ 251.92
RF-671	Tuerca para botón flux	\$ 214.21
RF-672	Botón fluxómetro electrónico Cr	\$ 169.33
 RF-673	Resorte para botón flux	\$ 23.41
 RF-674	Empaque estopero flux	\$ 23.42
RF-675	Estopero para botón flux	\$ 137.20
RF-680	Rondana delrin p/mingitorio	\$ 4.95
RF-693	Émbolo macho del RIN 4.8 LPF	\$ 75.69
RF-694	Rondana bushing 4.8 LPF	\$ 99.24
RF-699	Émbolo macho 0.5 LPF	\$ 75.69
RF-700	Rondana para mingitorio 1.5 L	\$ 45.24
RF-718	Rondana bushing 0.5 LPF	\$ 99.24
 RF-757	Empaque p/tuerca spud 19 ming.	\$ 6.41
RF-788	Rondana bushing 1 LPF	\$ 99.24
RF-789	Émbolo macho del RIN 1 LPF	\$ 75.69
RF-812	Niple para flux de pedal 7.3" Long	\$ 454.62
RF-813	Chapetón 42mm p/flux de pedal	\$ 161.40
RF-873	Perno émbolo /autolimpieza /WC-ming.	\$ 55.60
RF-874	Rondana bushing embolo de autolimpieza	\$ 129.51
RF-923	Perno émbolo de autolimpieza de ming.	\$ 151.15
RF-924	Rondana bushing emb de autlimpieza 4.8 L	\$ 123.04
 RF-941	Rondana de hule spud de 38 mm	\$ 16.41

FLUXÓMETROS

Modelo	Descripción	Precio
 RF-983	Casquillo estopero para flux.	\$ 68.72
RF-999-C	Niple recto 32 mm. x 40cm. long Cr	\$ 240.41
RF-1005	Rondana bushing embolo autolimpieza	\$ 123.04
RF-1070	3.5L Botón para SF-586	\$ 169.33
 SF-002	Asiento con perno émbolo fluxómetro 6 lt	\$ 124.76
 SF-008-C	Llave retención armada cromada	\$ 1,049.89
SF-009	Niple recto reducción 32-19 p/ming. torio	\$ 220.38
 SF-012	Perno con asiento estopero para o'ring para manija	\$ 73.11
SF-014	Llave de retención RECT FLUX	\$ 1,228.57
SF-015	Mecanismo cierre llave de retención	\$ 167.91
 SF-015-C	Mecanismo cierre llave de retención	\$ 191.21
SF-024	Emb. arm. p/fluxómetro regular	\$ 700.85
SF-039	Niple recto reducción 32-19 fluxómetro	\$ 234.51
SF-054	Kit émbolo fluxómetro	\$ 259.53
	RF-005 Rond. hule émb.hembra p/flux. RF-015 Torn. No.8-32 NC x 1/2 RF-016 Rond. neop. cúpula flux. RF-052 Llantita S-14 vulcanizada RF-075 Rondana S-21 vulcanizada	
SF-055	Kit llave de retención	\$ 111.07
	RF-637 Empaque p/llave de retención flux RF-035 O'ring 2-123 RF-234 Res. émbolo llave ret. RF-256 Asiento p/émbolo RH-337 O'ring 2-114	

Modelo	Descripción	Precio
SF-056	Kit Manija y pedal	\$ 74.22
	RF-024 Rond. p/manija flux. RF-025 Emp. cónico p/estopero RF-030 Resorte estopero RF-120 O'ring 2-006 p/perno estopero	
SF-057	Kit rondanas spud de 19 mm	\$ 47.08
	RF-044 Rond. hule tuerca F-2 D 32 mm RF-081 Rond. fibra tca. 19 RF-757 Empaque p/tca. spud 19 ming.	
SF-058	Kit rondanas spud de 32 mm	\$ 49.86
	RF-044 Rond. hule p/tca. F-2 de 32 mm RF-045 Rond. fibra p/tca. de 32 mm RF-049 Rond. fibra tca. spud 32 mm RF-050 Rond. hule tca. spud 32-38 mm	
SF-059	Kit rondanas spud de 38 mm	\$ 41.53
	RF-060 Rond. fibra tca. spud 32-38 mm RF-941 Rond. hule spud 38 mm	
SF-063	Tuerca F-2 de 32 mm	\$ 182.34
SF-064	Rondana y tuerca spud 32 mm	\$ 181.15
 SF-070	Rondana y tuerca spud 38 mm	\$ 178.83
SF-077	Rondana y tuerca spud 19 mm	\$ 166.90
SF-100	Émbolo armado fluxómetro 3 lts	\$ 688.43
SF-102	Asiento c/perno emb p/flux. 3L	\$ 128.23
 SF-106	Manija armada para fluxómetro cromo	\$ 497.30
 SF-110	Estopero armado con cuerda fluxómetro	\$ 261.32
 SF-113	Portapedal armado 3 y 6 lts	\$ 837.11

FLUXÓMETROS









Modelo	Descripción	Precio	Modelo	Descripción	Precio
SF-124	Émbolo armado fluxómetro 6 lts	\$ 700.85	 SF-744	Émbolo Flux. 0.5 LPF autolimpieza	\$ 620.33
SF-147	Niple muro fluxómetro de pedal	\$ 1,430.51			
 SF-157	Perno arm. niquelado para flux. elect.	\$ 189.74	 SF-760	Kit de empaques para carcasa	\$ 196.03
 SF-177	Cople interior con perno armado	\$ 601.05	 SF-761	Kit de empaques para botón Nota: Para modelo anterior botón SF-914	\$ 93.35
SF-179	Cople ext. arm. cuerda izq. p/flux. Bat.	\$ 745.13	 SF-763	Anillo de seguridad para fluxómetro	\$ 833.98
 SF-555	Sensor p/fluxómetro corriente CIO19/1000	\$ 2,714.48	 SF-764	Portapila flexible p/flux. electrónico	\$ 373.45
 SF-556	Sensor p/fluxómetro d/bat	\$ 2,714.48	 SF-765	Émbolo flux. 1.9 LPF	\$ 556.90
SF-557	Dispositivo actuador elec. flux bat.	\$ 9,902.86	 SF-774	Émbolo Flux. 3 LPF autolimpieza	\$ 640.39
 SF-586	Botón accionador mecánico fluxómetro nuevo	\$ 644.35	 SF-781	Cúpula arm. para flux. de autolimpieza	\$ 818.62
SF-588	Portapedal armado para flux. 3 y 6 L	\$ 1,467.84	 SF-782	Asiento con perno m. flux. 6 L autolimpieza	\$ 128.23
SF-589	Botón accionador mec. p/flux. electr.	\$ 492.10	SF-783	Asiento c perno emb flux 4.8 L autolimpieza	\$ 128.23
 SF-665	Tuerca adaptación 32 mm c/empaques	\$ 262.01	 SF-799	Boton de seguridad p/fluxometros	\$ 38.69
 SF-719	Émbolo Flux. 6 LPF autolimpieza	\$ 651.95	 SF-804	Émbolo Flux. 3.5 LPF autolimpieza	\$ 640.39
 SF-741	Émbolo Flux. 4.8 LPF autolimpieza	\$ 649.15	 SF-805	Dispositivo electrónico para Flux. de batería	\$ 7,395.68
 SF-743	Émbolo Flux. 1 LPF autolimpieza	\$ 591.96			

FLUXÓMETROS

Modelo	Descripción	Precio	Modelo	Descripción	Precio
SF-914	Botón accionador p flux CR NIV. ANT.	\$ 644.35			
SF-926	Perno con inserto p/ botón SF-586	\$ 122.43			
SF-930	Kit mtto preventivo botón actual SF-586	\$ 74.22			

REGADERAS



Modelo	Descripción	Precio	Modelo	Descripción	Precio
 RR-003	Empaque de vinil para nudo regadera	\$ 9.02	RR-028	Plato regadera H-500 CR	\$ 121.63
RR-005	Émbolo delrin AC-50	\$ 25.25	RR-032	Rondana hule regadera H-100	\$ 55.67
RR-009	Emblema regadera H-1000	\$ 14.28	RR-038	Opresor 1/8"-40 UNC	\$ 6.40
 RR-010	Disco guía delrin AC-50	\$ 44.63	 RR-040	Empaque hule H-600	\$ 33.71
 RR-011	Emblema Helvex AC-50	\$ 16.85	RR-041	Plato regadera H-600 Cr	\$ 157.63
RR-012	Tornillo moleteado émbolo p/reg. cromo	\$ 68.54	RR-042	Tornillo para plato H-600 Cr	\$ 29.17
RR-013	Tuerca para cuerpo campana cromo	\$ 316.66	RR-044	Empaque regadera manual Futura	\$ 7.22
RR-014	Nudo manzana grande AC-10 cromo	\$ 303.18	 RR-047	Empaque vinil nudo H-600	\$ 4.48
RR-016	Mariposa para nudo de reg./ cromo	\$ 184.88	RR-054	O'ring 2-227	\$ 16.85
RR-018	Rondana hule base mural	\$ 21.40	RR-071	Tuerca para cuerpo reg. AC-110	\$ 425.56
RR-019	Tapa cuadrada delrin AC-20 cromo	\$ 45.50	RR-073	Opresor No. 8-32 UNC	\$ 14.02
 RR-023	O'ring 2-024	\$ 5.87	 RR-076	Niple de muro regadera manual RM3 Cr	\$ 173.22
RR-025	Tornillo 3 regadera H-500	\$ 39.32	RR-076-S	Niple de muro regadera manual RM3 S	\$ 208.12
RR-027	Empaque hule regadera H-500	\$ 40.14	 RR-081	O'ring 2-010	\$ 3.32

REGADERAS

Modelo	Descripción	Precio	Modelo	Descripción	Precio
	RR-082 O'ring 2-113	\$ 4.48	RR-250	Inserto para tuerca regadera cromo	\$ 17.96
	RR-085 Rondana latón vulcanizada	\$ 69.17	RR-254	Arillo base para regadera	\$ 56.53
RR-086	Émbolo para sello regadera man. RM-3 N	\$ 20.69	RR-258	Plato p/regadera H-2000 cromo	\$ 106.66
RR-100	Seguro terminal manguera flexible p/reg. mon. RM3	\$ 8.14	RR-259	O'ring 2-212	\$ 5.09
RR-105	Tornillo 10-24 UNC-2A x 1/2"	\$ 3.32	RR-264	Plato regadera H-300 cromo	\$ 180.30
RR-106	Opresor Aller 8-32 UNC 24/1/8"	\$ 20.73	RR-265	Empaque para plato regadera	\$ 38.07
RR-107	Opresor Allen 8-32 UNC-2A x 1/4"	\$ 7.23	RR-273	Tornillo phillips 10-24 X 21/4"	\$ 44.47
	RR-116 Empaque para manguera flexible p/regadera man. RM-3	\$ 6.77	RR-284	Tuerca cuerpo regadera H-900 Nuva cromo	\$ 166.15
RR-123	Tuerca unión para nudo H-500	\$ 32.98	RR-290	Plato para regadera H-900 Nuva cromo	\$ 158.37
RR-139	O'ring 2-211	\$ 5.10	RR-291	O'ring 2-026 p/salidas de lavabo	\$ 3.83
RR-142	Tuerca unión nueva	\$ 52.88	RR-294	O'ring 2-128	\$ 11.02
	RR-144 Anillo plástico para regadera H-200	\$ 38.20	RR-298	Conector para regadera cromo	\$ 199.97
	RR-162 Rondana neopreno para nudo	\$ 18.61	RR-301	Plato p/regadera H-100 cromo	\$ 341.74
RR-195	Niple para regadera manual	\$ 15.97	RR-307	Cuerpo interior regadera H-900 Nuva	\$ 321.96
RR-198	O'ring 2-037	\$ 22.01	RR-310	Empaque interior p/base de regadera	\$ 18.51
RR-201	Brazo para regadera econ. H-200 cromo	\$ 328.31	RR-311	Tornillo para plato regadera H-3000 Cr	\$ 82.96
RR-202	Chapetón para brazo regadera cromo	\$ 206.34	RR-319	O'ring 2-177	\$ 165.91
RR-204	Empaque hule plato regadera H-400	\$ 14.28	RR-320	Empaque para boquilla de regadera	\$ 13.72
RR-207	Chapetón maneral Óptima cromo	\$ 154.14	RR-321	Empaque para tornillo regadera	\$ 2.39
RR-211	Nudo regadera H-400 Antiqua cromo	\$ 160.28	RR-322	Empaque para regadera H-3000	\$ 6.25
RR-212	Plato regadera H-400 Antiqua cromo	\$ 244.95	RR-323	O'ring 2-157	\$ 87.10
RR-220	Soporte regadera manual Futura cromo	\$ 479.51		RR-337 Chapetón para brazo regadera cromo	\$ 239.42
	RR-249 Inserto para tuerca regadera Antiqua	\$ 15.59	RR-338	Antical individual para regadera	\$ 6.45
			RR-341	Filtro para regadera	\$ 89.05
			RR-350	Conector Miura cromo	\$ 273.77
			RR-363	Tornillo 1/4"-20 x 0.350"	\$ 69.16
			RR-364	Chapetón cuadrado regadera Kúbica Cr	\$ 294.92
			RR-387	Conector p/brazo de regadera Kúbica Cr	\$ 303.44
			RR-393	Conector para regadera Kúbica cromo	\$ 243.89
			RR-410	Tuerca para regadera Premier	\$ 74.72
			RR-431	Tapón p/soporte de sujeción de regadera Cr	\$ 73.78
			RR-433	Barra de sujeción p/reg. deslizable Cr	\$ 847.76
			RR-439	Casquillo de desviador de regadera Nuva Cr	\$ 479.32
			RR-442	Tapón guía p/casquillo desviador	\$ 32.17
			RR-496	Tapete anticalcáreo p/reg. Premier	\$ 331.42
			RR-497	Difusor para regadera premier TR	\$ 147.51
			RR-499	Empaque para regadera	\$ 19.13
			RR-501	Soporte de regadera Nuva manual Cr	\$ 439.90
			RR-514	Tapete con anticalcareos reg Kúbica	\$ 375.61
			RR-552	Empaque para regadera Vértika	\$ 43.18
			RR-554	Nudo para regadera Cr	\$ 475.38
			RR-555	Chapetón para regadera Vértika cromo	\$ 351.89
			RR-574	Tuerca hexagonal p/nudo regadera H-201	\$ 74.27

REGADERAS

Modelo	Descripción	Precio
RR-586	Empaque p/codo regadera ducha	\$ 22.32
RR-601	Chapetón cuadrado p/brazo reg. Kúbica Cr	\$ 477.79
RR-604	Tapete antical d/reg kubica 6"	\$ 347.63
RR-610	Tapete anticalcáreo para regadera H-201	\$ 354.37
RR-612	Plato para regadera H-201 cromo	\$ 165.02
RR-613	Difusor para regadera H-201 Explora	\$ 117.08
RR-620	O'ring 2-042	\$ 19.60
RR-622	Botón de sujeción p/regadera Kúbica Cr	\$ 74.15
RR-667	Cpo. Distribuidor d/reg.H900 Nuva	\$ 42.05

	RR-704	Tapete anticalcáreo para regadera	\$ 366.73
---	---------------	-----------------------------------	-----------

RR-705	Plato regadera doble	\$ 64.64
RR-710	Difusor para regadera	\$ 9.41
RR-733	Tapete anticalcáreo regadera Vértika	\$ 394.54
RR-740	Opresor Allen 5-40 UNC X 1/4"	\$ 6.40
SR-004	Cpo. reg. RM-3 c/tubos Cr	\$ 1,565.52

	SR-005	Manguera armada regadera RM-3 cromo	\$ 474.68
--	---------------	-------------------------------------	-----------

SR-005-S	Manguera armada regadera RM-3	\$ 1,193.65
-----------------	-------------------------------	-------------

	SR-013	Émbolo armado regaderas AC	\$ 199.62
---	---------------	----------------------------	-----------

	SR-027	Cabezal p/reg. manual Futura cromo	\$ 355.44
---	---------------	------------------------------------	-----------

SR-044	Nudo armado p/regadera H-400 cromo	\$ 261.20
---------------	------------------------------------	-----------

	SR-080	Economizadora para regaderas 10 lts x min	\$ 93.90
---	---------------	---	----------

Modelo	Descripción	Precio	
	SR-086	Chapetón para brazo regadera cromo	\$ 156.22

SR-095	Nudo arm. p/reg. H-800 Elegance CR	\$ 417.32
---------------	------------------------------------	-----------

	SR-101	Conector regadera Celta RM-21	\$ 272.07
---	---------------	-------------------------------	-----------

SR-103	Chapetón p/ reg. c/ancla Elegance Cr	\$ 456.78
---------------	--------------------------------------	-----------

SR-104	Perilla armada para regadera	\$ 169.07
---------------	------------------------------	-----------

SR-124	Pija	\$ 47.98
---------------	------	----------

SR-137	Manguera 1/2" x 1/4" NPSM 15" L Cr	\$ 247.95
---------------	------------------------------------	-----------

SR-142	Varilla armada p/reg. manual RM-12 Cr	\$ 1,189.03
---------------	---------------------------------------	-------------

	SR-143	Soporte armado p/reg. manual RM-12 Cr	\$ 790.57
--	---------------	---------------------------------------	-----------

SR-156	Varilla armada p/reg. manual RM-13 Cr	\$ 1,170.45
---------------	---------------------------------------	-------------

SR-157	Soporte arm. reg. man. Vértika RM-13 Cr	\$ 1,291.47
---------------	---	-------------

SR-157-SD	Soporte arm. reg. man. Vértika RM-13-SD	\$ 1,549.73
------------------	---	-------------

SR-158	Juego de soportes p/reg. manual RM 26 Cr	\$ 859.76
---------------	--	-----------

	SR-159	Varilla armada p/regadera manual Cr	\$ 1,157.65
--	---------------	-------------------------------------	-------------

SR-160	Chapetón c/soporte p/reg. manual Cr	\$ 1,205.81
---------------	-------------------------------------	-------------

SR-161	Cuerpo con varilla arm p/eg. manual Cr	\$ 2,723.17
---------------	--	-------------

SR-162	Ancla chapetón c/soporte Cr	\$ 980.49
---------------	-----------------------------	-----------



SR-175	Chapetón con O'ring p/brazo de reg. Gde.	\$ 243.86
---------------	--	-----------

SR-176	Cpo c/varilla arm. p/reg RM-17	\$ 2,335.18
---------------	--------------------------------	-------------











SR-177	Kit empques p/varilla RM	\$ 50.62
---------------	--------------------------	----------

	SR-173	Cpo c/varilla arm para regadera RM-14	\$ 2,765.79
---	---------------	---------------------------------------	-------------

REGADERAS

Modelo	Descripción	Precio	Modelo	Descripción	Precio
	SR-186 Cabezal para regadera Antiqua Cr	\$ 1,637.42			
SR-195	Tapón con O'ring para barra spt de reg cr	\$ 71.63			
SR-211	Cabezal para regadera RM-12-H101	\$ 1,265.93			
SR-213	Varilla armada para cuerpos nuevos de regadera	\$ 939.74			
SB-1009					
	Kit 5 pzas. economizador reg. 8.3 Lts. X min.	\$ 680.63			
SB-1010					
	Kit 5 pzas. economizador reg. 5.6 Lts. X min.	\$ 680.63			

ESPECIALES

Modelo	Descripción	Precio	Modelo	Descripción	Precio
 RB-851	Llave inglesa 9"	\$ 487.23	SB-1029-S	Cabezal p/regadera manual Nuva satin	\$ 963.30
RB-852	Estuche para herramienta Helvex	\$ 527.32	SB-1038	Kit tornillo taquete llave p/secador d/manos	\$ 118.73
RB-853	Llave niquelada para dosificador	\$ 72.26	SB-1060	Sensor para jabonera líquida MB-1011	\$ 2,415.20
RB-909	Tapete anticalcáreo Reg. H-3008	\$ 349.67	 SB-1061	Kit llave y cerradura dosificadora	\$ 301.90
RB-910	Tapete anticalcáreo Reg. H-3009	\$ 349.67	SB-1062	Deposito dispensador de jab. MB-1100	\$ 120.76
RB-911	Tapete anticalcáreo Reg. H-3010	\$ 482.94	SB-1064	Carbón p/secador de manos MB-1012	\$ 187.03
RB-912	Tapete anticalcáreo Reg. H-3011	\$ 524.84	SB-1108	Valv. dosificadora de espuma p/MB-1101	\$ 602.03
RB-913	Tapete anticalcáreo Reg. H-3012	\$ 835.98	SB-1109	Sensor p/dosificador de espuma MB-1101	\$ 2,079.65
RB-914	Tapete anticalcáreo Reg. H-3013	\$ 1,159.45	SB-1110	Cabezal reg. manual 5 chorros RMB-30	\$ 1,533.86
SB-328	Valv check p/MBP arm.	\$ 234.67	SB-1110-S	Cabezal reg. manual 5 chorros RMB-30-S	\$ 1,763.06
 SB-804	Manguera p/reg. manual RM-20 y RM-21	\$ 474.68	 SB-1111	Reg. manual de 3 chorros	\$ 1,117.15
SB-804-S	Manguera p/reg. RM-20 y RM-21 satin	\$ 1,193.65	SB-1111-S	Reg. manual de tres chorros/satin	\$ 1,285.45
SB-903	Cabezal p/regadera RM-23	\$ 2,400.65	SB-1132	Cable de impulso para sin sarro S-25 Vul	\$ 825.44
SB-904	Cabezal p/regadera RM-26	\$ 2,313.59	SB-1133	Porta baterías para MB-1101	\$ 119.60
 SB-905	Cabezal p/regadera RM-25	\$ 1,289.72	SB-1237	Valvula dosif jabón liq MB-1102-AIB	\$ 602.03
 SB-912	Soporte deslizable de regadera	\$ 1,359.94	 SB-1241	Valvula dosificadora jabón liq MB-1100	\$ 777.34
 SB-985	Cabezal p/monomando de cocina E-305	\$ 2,477.57	SB-1234	Control remoto ATE	\$ 1,159.93
 SB-987	Cabezal para regadera manual RM-28	\$ 777.93	SB-1259	Dispositivo electrónico MB-1102-AIB	\$ 2,633.39
 SB-988	Cabezal cinco chorros Reg. man. RM-29	\$ 1,433.34	SB-1267	Tapete anticalcáreo H3004	\$ 239.15
SB-1016	Economizador p/regadera 6L	\$ 93.90			
 SB-1029	Cabezal p/regadera manual Nuva	\$ 837.16			

CERÁMICOS

Modelo Descripción Precio

REFACCIONES DE MINGITORIO



CE Cartucho TDS para mingitorio MGS-E y MGO-E \$ 1,020.00

DE-CH Dispositivo TDS para reemplazo MGS o MGO \$ 1,096.50



CE-CH Cartucho TDS para reemplazo modelo DE-CH \$ 1,020.00

LLE Llave para cartuchos TDS \$ 86.01



CE-2 Cartucho TDS2 para mingitorio seco \$ 1,479.00

DE-2 Cartucho TDS2 mingitorio seco Gobi Negev \$ 1,601.00

SX-RF-736 Empaque para spud de 19 mm \$ 45.50

SX-RF-750 Empaque para brida de mingitorio \$ 5.25



SX-RF-766 Tuerca para codo articulado mingitorio seco \$ 42.02



SX-RF-767 Tuerca para dispositivo TDS \$ 50.78

SX-RF-772 Tubo codo para mingitorio MGS-E y MGO-E \$ 129.82



SX-RF-817 Conector para céspol \$ 14.02

SX-RF-933 Conector para céspol TDS2 \$ 33.54

SX-RF-1111 Tubo para codo mingitorio TDS2 \$ 66.79

SX-RF-1141 Codo para desagüe TDS doble esfera \$ 51.06

SX-SF-626-AI Contra para mingitorio armada acero inoxidable \$ 388.55

SX-SF-645 Brida para mingitorio refacción \$ 229.30

SX-SF-646 Kit de fijación ancla, pijas y tornillos \$ 91.22

SX-SF-647 Spud para mingitorio 19 mm \$ 136.52

SX-SF-702 Kit de contra armado para mingitorio \$ 96.67

SX-SF-746 Conjunto para instalación mingitorio seco \$ 341.10



SX-SF-748 Conjunto para instalación de mingitorio cascada \$ 204.38

SX-SF-848 Difusor para mingitorio MG Mojave \$ 997.58

SX-SF-851 Contra armada MG Mojave \$ 813.67

Modelo Descripción Precio

SX-SF-852 Césped Mojave \$ 347.49

SX-SF-856 Kit tuercas y empaque para difusor MG Mojave \$ 197.44

SX-SF-857 Kit tuerca / empaque para conexión mingitorio \$ 49.21

SX-SF-858 Césped MG Mojave \$ 165.03

SX-SF-946 Codo armado para contras TDS2 \$ 159.87

SX-SF-1050 Kit de contra larga para mingitorio \$ 153.71

REFACCIONES DE WC

SX-RF-737 Esparrago de WC para fluxómetro spud 38 mm \$ 283.65

SX-RF-738 Rondana de spud para taza de fluxómetro 38 mm \$ 24.85

SX-RF-739 Empaque para spud de 38 mm \$ 68.25

SX-RF-740 Tuerca plana de WC para fluxómetro spud 38 mm \$ 129.89

SX-RF-831 Tapa para tanque TT1 y TT2 Drakar blanco \$ 273.44

SX-RF-831-M Tapa para tanque TT1 y TT2 Drakar marfil \$ 273.44

SX-RF-832 Tapa para tanque TT1-2 y TT2-2 Ródano blanco \$ 452.96

SX-RF-832-M Tapa para tanque TT1-2 y TT2-2 Ródano marfil \$ 452.96

SX-RF-833 Tapa para tanque TT1-3 y TT2-3 Bolmen blanco \$ 452.96

SX-RF-833-M Tapa para tanque TT1-3 y TT2-3 Bolmen marfil \$ 452.96

SX-RF-834 Tapa para tanque TTP-2 Ródano \$ 452.96

SX-RF-834-M Tapa para tanque TTP-2 Ródano marfil \$ 452.96

SX-RF-835 Tapa para tanque TTP-3 Bolmen \$ 452.96

SX-RF-835-M Tapa para tanque TTP-3 Bolmen marfil \$ 452.96



SX-RF-840 Empaque esponjoso para WC \$ 48.33



SX-RF-846 Filtro para válvula de admisión para WC \$ 3.49



SX-RF-872 Tapa para tanque TTR Olimpia \$ 258.24

SX-RF-951 Cuello flexible para sanitario 100 mm \$ 140.86

SX-RF-967 Cople para taza suspendida 4 3/4" \$ 82.26

SX-RF-970 Tubo PVC para cople 4 3/4" \$ 153.83

SX-RF-1003 Empaque de silicón para válvula 2" \$ 17.12

SX-RF-1004 Empaque de silicón para válvula 3" \$ 20.56



SX-RF-1010 Empaque esponjoso para WC 3" \$ 49.66



SX-RF-1020 Tapa para tanque Murano \$ 1,216.65





SX-RF-1024 Tapa para tanque OP Rivoli Plus \$ 1,701.38



SX-RF-1079 Tapa para tanque Miura \$ 581.15

CERÁMICOS

Modelo	Descripción	Precio
 SX-RF-1080	Tapa para tanque Option	\$ 299.55
 SX-RF-1090	Tapa para tanque OP Capri Plus	\$ 1,701.38
SX-RF-1106	Llave 7/16" para instalación taza Miura	\$ 253.70
 SX-RF-1114	Tapa para tanque Drakar16	\$ 273.44
SX-RF-1158	Tapa para tanque WC Austral de botón	\$ 276.71
SX-RF-1159	Tapa tanque WC Austral de palanca	\$ 216.54
SX-RF-1215	Tapa tanque WC Miura16 TCC	\$ 1,606.12
SX-RF-1224	Empaque de silicón3" para WC Miura16	\$ 20.56
SX-SF-634	Kit válvula para tanque calibrado 4.8 L TT1	\$ 577.25
SX-SF-635	Kit válvula para tanque calibrado 3 y 6 L TT2	\$ 577.25
 SX-SF-636	Botón para tapa tanque 4.8 L CR	\$ 132.58
 SX-SF-637	Botón para tapa tanque 3 y 6 L CR	\$ 132.58
SX-SF-643	Juego de cubre pijas WC blanco	\$ 47.25
SX-SF-643-M	Juego de cubre pijas WC marfil	\$ 52.50
 SX-SF-648	Spud para taza fluxómetro de 38 mm	\$ 402.57
 SX-SF-691	Kit para anclaje de WC blanco	\$ 107.72
SX-SF-691-M	Kit para anclaje de WC marfil	\$ 107.72
SX-SF-699	Kit de palanca para TTP	\$ 171.24
 SX-SF-704	Kit de tornillos para sujeción de tanque	\$ 107.72
SX-SF-705	Kit valv para tanque palanca Rodano	\$ 731.93
 SX-SF-707	Extensión válvula de admisión con o'ring	\$ 22.76
SX-SF-708	Kit válvula para tanque calibrado 4.8 L Rodano	\$ 577.25
SX-SF-709	Kit válvula para tanque doble descarga Rodano	\$ 577.25
SX-SF-710	Kit válvula para tanque calibrado 4.8 L Bolmen	\$ 577.25
SX-SF-711	Kit válvula para tanque doble descarga Bolmen	\$ 577.25
SX-SF-734	Kit de sujeción AT-1	\$ 114.62
SX-SF-735	Kit de sujeción AT-2	\$ 132.58

Modelo	Descripción	Precio
SX-SF-745-B	Juego de cubre pijas WC blanco	\$ 106.77
SX-SF-771	Kit de fijación taza trampa oculta	\$ 193.33
SX-SF-785	Kit de sujeción para asiento AT-4	\$ 324.53
SX-SF-798	Juego de tuercas y rondanas para taza suspendida	\$ 149.79
SX-SF-815	Kit de válvula de admisión y válvula de descarga 3"	\$ 577.25
SX-SF-839	Asiento para OP Capri Plus	\$ 1,625.54
 SX-SF-840	Kit de sujeción para OP Capri Plus	\$ 244.28
 SX-SF-842	Kit válvula para tanque OP Capri Plus	\$ 763.47
SX-SF-851	Contra armada MG Mojave	\$ 813.67
SX-SF-861	Kit válvula sapo 3"	\$ 175.83
SX-SF-883	Kit válvula tanque Austral de palanca	\$ 598.19
SX-SF-884	Palanca para WC Austral	\$ 164.40
SX-SF-904	Kit de sujeción tapa AT5	\$ 315.40
SX-SF-910	Sensor WC Miura16 TCC	\$ 842.62
SX-SF-911	Módulo de control WC Miura16 TCC	\$ 843.00
SX-SF-912	Válvula de llenado WC Miura16 TCC	\$ 3,813.37
SX-SF-913	Botón WC Miura16 TCC	\$ 3,590.66
SX-SF-942	Kit de válvula de descarga	\$ 645.21
SB-1147	Kit de sujeción asiento AF-2	\$ 157.44

REFACCIONES DE LAVABO

SX-RF-898	Chapetón para lavabo CR	\$ 39.59
SX-RF-1011	Chapetón para lavabo Futura 1y 3	\$ 31.55
SX-SF-794	Kit de sujeción para lavabo Marcus	\$ 154.98

HOJAS DE
REFACCIONES
CERÁMICAS

REFACCIONES ORIGINALES

Refacciones Originales



garantía de calidad

MG GOBI TDS2



#	Modelo	Descripción
1	CE-2	Cartucho TDS2 para mingitorio seco
2	SX-SF-1050	Kit de contra largo armado para mingitorio
3	SX-SF-646	Kit de fijación ancla, pijas y tornillos
4	SX-RF-750	Empaque para brida de mingitorio
5	SX-RF-767	Tuerca para dispositivo TDS
6	SX-RF-1111	Tubo para codo mingitorio TDS2
7	SX-RF-766	Tuerca para codo articulado mingitorio seco
8	SX-RF-933	Conector para céspeol TDS2
9	LLE	Llave para cartuchos TDS
10	SX-RF-1141	Codo para desagüe TDS doble esfera
11	SX-SF-946	Codo armado para contras TDS2

Para cualquier duda sobre refacciones cerámicas comunícate al Departamento Oficina de Refacciones

MG NEGEV TDS2



#	Modelo	Descripción
1	CE-2	Cartucho TDS2 para mingitorio seco
2	SX-SF-1050	Kit de contra largo armado para mingitorio
3	SX-SF-646	Kit de fijación ancla, pijas y tornillos
4	SX-RF-750	Empaque para brida de mingitorio
5	SX-RF-767	Tuerca para dispositivo TDS
6	SX-RF-1111	Tubo para codo mingitorio TDS2
7	SX-RF-766	Tuerca para codo articulado mingitorio seco
8	SX-RF-933	Conector para céspol TDS2
9	LLE	Llave para cartuchos TDS
10	SX-RF-1141	Codo para desague TDS doble esfera
11	SX-SF-946	Codo armado para contras TDS2

Para cualquier duda sobre refacciones cerámicas comunícate al Departamento Oficina de Refacciones

MG MOJAVE TDS2



#	Modelo	Descripción
1	CE-2	Cartucho TDS2 para mingitorio seco
2	SX-SF-1050	Kit de contra largo armado para mingitorio
3	SX-SF-646	Kit de fijación ancla, pijas y tornillos
4	SX-RF-750	Empaque para brida de mingitorio
5	SX-RF-767	Tuerca para dispositivo TDS
6	SX-RF-1111	Tubo para codo mingitorio TDS2
7	SX-RF-766	Tuerca para codo articulado mingitorio seco
8	SX-RF-933	Conector para céspol TDS2
9	LLE	Llave para cartuchos TDS
10	SX-RF-1141	Codo para desagüe TDS doble esfera
11	SX-SF-946	Codo armado para contras TDS2

Para cualquier duda sobre refacciones cerámicas comunícate al Departamento Oficina de Refacciones

MG MOJAVE



#	Modelo	Descripción
1	SX-SF-646	Kit de fijación ancla, pijas y tornillos
2	SX-SF-856	Kit tuercas y empaque para difusor MG Mojave
3	SX-SF-848	Difusor para mingitorio MG Mojave
4	SX-SF-851	Contra armada MG Mojave
5	SX-SF-857	Kit tuerca/empaque para conexión mingitorio
6	SX-SF-852	Céspol MG Mojave
7	SX-RF-767	Tuerca para dispositivo TDS
8	SX-RF-750	Empaque para brida de mingitorio
9	SX-RF-933	Conector para céspol TDS2
10	SX-SF-626-AI	Contra para mingitorio armada AI

Para cualquier duda sobre refacciones cerámicas comunícate al Departamento Oficina de Refacciones

MG FERRY

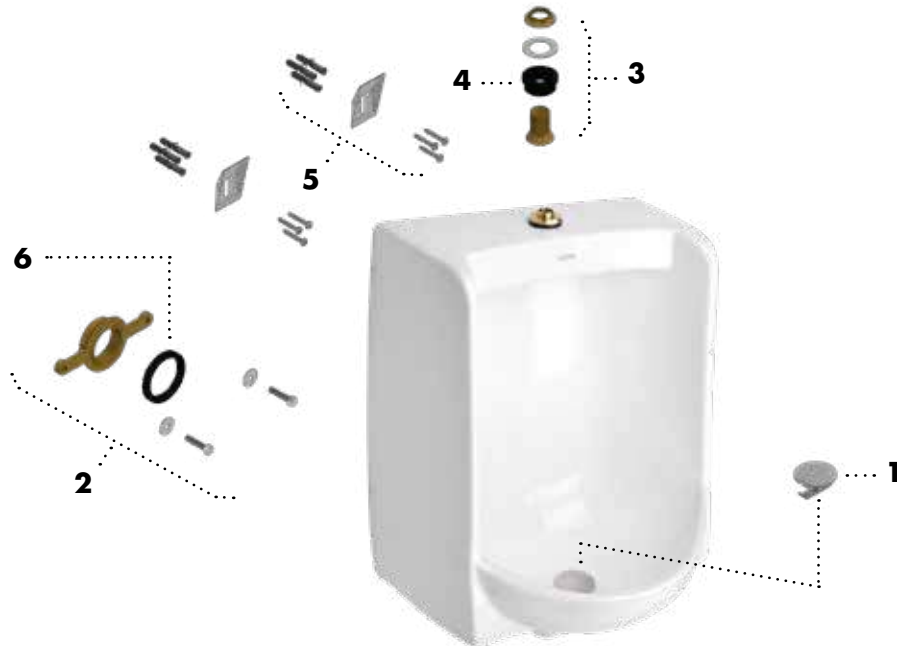

#	Modelo	Descripción
1	SX-SF-626-AI	Contra para mingitorio armada acero inoxidable
2	SX-SF-645	Brida para mingitorio
3	SX-SF-647	Spud para mingitorio 19 mm
4	SX-RF-736	Empaque para spud de 19 mm
5	SX-SF-748	Conjunto para instalación de mingitorio cascada
6	SX-RF-750	Empaque para brida de mingitorio

Para cualquier duda sobre refacciones cerámicas comunícate al Departamento Oficina de Refacciones

BOLMEN16

4.8 LPD



#	Modelo	Descripción
1	SX-SF-636	Botón para tapa tanque 4.8 L cromo
2	SX-RF-833	Tapa para tanque Bolmen16
3	SX-SF-942	Kit válvula para tanque calibrado 4.8 L TTI
4	SX-RF-1224	Empaque de silicón para válvula 3"
5	SX-RF-846	Filtro para válvula de admisión para WC
6	SX-SF-704	Kit de tornillos para sujeción de tanque
7	SX-RF-1010	Empaque esponjoso para WC 3"
8	SX-SF-691 SX-SF-691-M (Marfil)	Kit para anclaje de WC blanco
9	SX-SF-643 SX-SF-643-M (Marfil)	Juego de cubre pijas WC blanco

Para cualquier duda sobre refacciones cerámicas comunícate al Departamento Oficina de Refacciones

RÓDANO16 4.8 LPD

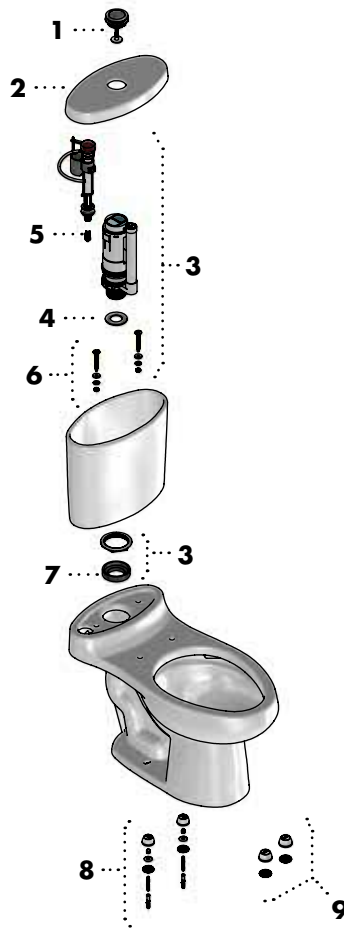

#	Modelo	Descripción
1	SX-SF-636	Botón para tapa tanque 4.8 L cromo
2	SX-RF-832	Tapa para tanque Rodano16
3	SX-SF-942	Kit válvula para tanque calibrado 4.8 L TT1
4	SX-RF-1224	Empaque de silicón para válvula 3"
5	SX-RF-846	Filtro para válvula de admisión para WC
6	SX-SF-704	Kit de tornillos para sujeción de tanque
7	SX-RF-1010	Empaque esponjoso para WC 3"
8	SX-SF-691 SX-SF-691-M (Marfil)	Kit para anclaje de WC blanco
9	SX-SF-643 SX-SF-643-M (Marfil)	Juego de cubre pijas WC blanco

Para cualquier duda sobre refacciones cerámicas comunícate al Departamento Oficina de Refacciones

WC DRAKAR 4.8 LPD



#	Modelo	Descripción
1	SX-SF-636	Botón para tapa tanque 4.8 L cromo
2	SX-RF-831	Tapa para tanque TT1 y TT2 Drakar blanco
3	SX-SF-634	Kit válvula para tanque calibrado 4.8 L TT1
4	SX-RF-1003	Empaque de silicón para válvula 2"
5	SX-RF-846	Filtro para válvula de admisión para WC
6	SX-SF-704	Kit de tornillos para sujeción de tanque
7	SX-RF-840	Empaque esponjoso para WC 2"
8	SX-SF-691 SX-SF-691-M (Marfil)	Kit para anclaje de WC blanco
9	SX-SF-643 SX-SF-643-M (Marfil)	Juego de cubre pijas WC blanco

Para cualquier duda sobre refacciones cerámicas comunícate al Departamento Oficina de Refacciones

WC DRAKAR16 4.8 LPD



#	Modelo	Descripción
1	SX-SF-636	Botón para tapa tanque 4.8 L cromo
2	SX-RF-1114	Tapa para tanque Drakar 16
3	SX-SF-942	Kit válvula para tanque calibrado 3 y 6 L TT2
4	SX-RF-1224	Empaque de silicón para válvula 3"
5	SX-RF-846	Filtro para válvula de admisión para WC
6	SX-SF-704	Kit de tornillos para sujeción de tanque
7	SX-RF-1010	Empaque esponjoso para WC 3"
8	SX-SF-691 SX-SF-691-M (Marfil)	Kit para anclaje de WC blanco
9	SX-SF-643 SX-SF-643-M (Marfil)	Juego de cubre pijas WC blanco

Para cualquier duda sobre refacciones cerámicas comunícate al Departamento Oficina de Refacciones

WC OLIMPIA 3.8 LPD



#	Modelo	Descripción
1	SX-SF-636	Botón para tapa tanque 4.8 L cromo
2	SX-RF-872	Tapa para tanque TTR Olimpia
3	SX-SF-942	Kit válvula para tanque calibrado 3.8 L Olimpia
4	SX-RF-846	Filtro para válvula de admisión para WC
5	SX-SF-704	Kit de tornillos para sujeción de tanque
7	SX-RF-1224	Empaque de silicona para válvula 3"
8	SX-SF-691 SX-SF-691-M (Marfil)	Kit para anclaje de WC blanco
9	SX-SF-643 SX-SF-643-M (Marfil)	Juego de cubre pijas WC blanco
10	SX-RF-1010	Empaque esponjoso para WC 3"

Para cualquier duda sobre refacciones cerámicas comunícate al Departamento Oficina de Refacciones

WC OPTION 4.8 LPD



#	Modelo	Descripción
1	SX-SF-636	Botón para tapa tanque 4.8 L cromo
2	SX-RF-1080	Tapa para tanque Option
3	SX-SF-942	Kit válvula para tanque Option
4	SX-RF-846	Filtro para válvula de admisión para WC
5	SX-SF-704	Kit de tornillos para sujeción de tanque
6	SX-RF-1224	Empaque de silicón para válvula 3"
7	SX-RF-1010	Empaque esponjoso para WC 3"
8	SX-SF-691	Kit para anclaje de WC blanco
9	SX-SF-643	Juego de cubre pijas WC blanco

Para cualquier duda sobre refacciones cerámicas comunícate al Departamento Oficina de Refacciones

WC AUSTRAL CON BOTÓN 3.8 LPD



#	Modelo	Descripción
1	SX-SF-636	Botón para tapa tanque 4.8 L cromo
2	SX-RF-1158	Tapa para tanque Austral de botón
3	SX-SF-942	Kit válvula para tanque Austral de botón
4	SX-RF-846	Filtro para válvula de admisión para WC
5	SX-SF-704	Kit de tornillos para sujeción de tanque
6	SX-RF-1010	Empaque esponjoso para WC 3"
7	SX-SF-691	Kit para anclaje de WC blanco
8	SX-RF-1224	Empaque de silicón para válvula 3"

Para cualquier duda sobre refacciones cerámicas comunícate al Departamento Oficina de Refacciones

WC AUSTRAL CON PALANCA 3.8 LPD



#	Modelo	Descripción
1	SX-SF-884	Palanca para WC Austral
2	SX-RF-1159	Tapa para tanque Austral de palanca
3	SX-SF-883	Kit válvula para tanque Austral de palanca
4	SX-RF-846	Filtro para válvula de admisión para WC
5	SX-SF-704	Kit de tornillos para sujeción de tanque
6	SX-RF-1010	Empaque esponjoso para WC 3"
7	SX-SF-691	Kit para anclaje de WC blanco

Para cualquier duda sobre refacciones cerámicas comunícate al Departamento Oficina de Refacciones

WC 2.5 2.5 LPD

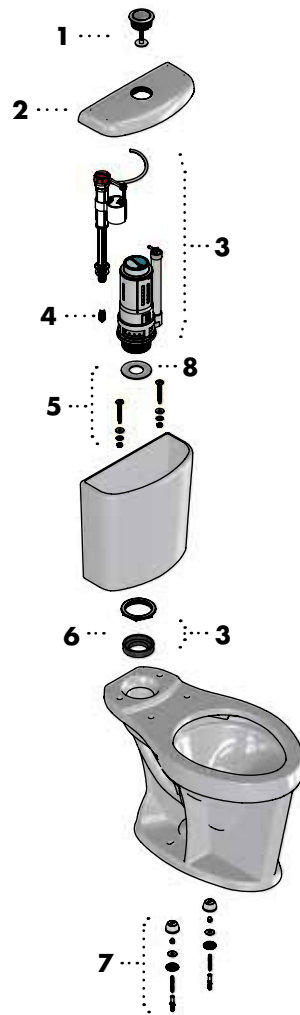

#	Modelo	Descripción
1	SX-SF-636	Botón para tapa tanque 4.8 L cromo
2	SX-RF-1210	Tapa para tanque WC 2.5
3	SX-SF-942	Kit válvula para tanque de botón
4	SX-RF-846	Filtro para válvula de admisión para WC
5	SX-SF-704	Kit de tornillos para sujeción de tanque
6	SX-RF-1010	Empaque esponjoso para WC 3"
7	SX-SF-691	Kit para anclaje de WC blanco
8	SX-RF-1224	Empaque de silicón 3"

Para cualquier duda sobre refacciones cerámicas comunícate al Departamento Oficina de Refacciones

WC MURANO 4.8 LPD

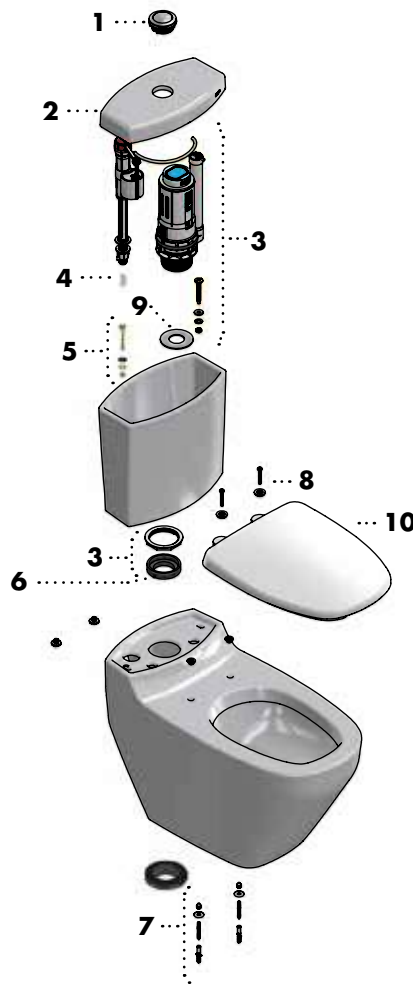

#	Modelo	Descripción
1	SX-SF-636	Botón para tapa tanque 4.8 L cromo
2	SX-RF-1020	Tapa tanque Murano
3	SX-SF-942	Kit de válvula para tanque Murano 3"
4	SX-RF-846	Filtro para válvula de admisión para WC
5	SX-SF-704	Kit de tornillos para sujeción de tanque
6	SX-RF-1010	Empaque esponjoso para WC 3"
7	SX-SF-771	Kit de fijación taza trampa oculta
8	SX-SF-785	Kit de sujeción para asiento AT-4
9	SX-RF-1224	Empaque de silicón para válvula 3"
10	AT-3	Asiento para WC Murano

Para cualquier duda sobre refacciones cerámicas comunícate al Departamento Oficina de Refacciones

WC MIURA16

4.8 LPD

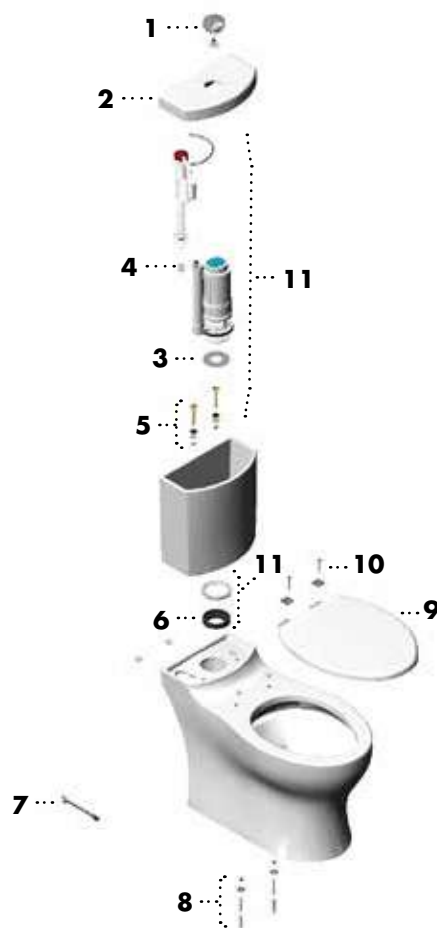

#	Modelo	Descripción
1	SX-SF-636	Botón para tapa tanque 4.8 L cromo
2	SX-RF-1079	Tapa para tanque Miura16
3	SX-RF-1224	Empaque de silicón 3"
4	SX-RF-846	Filtro para válvula de admisión para WC
5	SX-SF-704	Kit de tornillos para sujeción de tanque
6	SX-RF-1010	Empaque esponjoso para WC 3"
7	SX-RF-1106	Llave 7/16"
8	SX-SF-771	Kit de fijación taza trampa oculta
9	AT-5	Asiento cierre lento antibacterial
10	SX-SF-904	Kit de sujeción AT-5
11	SX-SF-942	Kit de válvula de descarga

Para cualquier duda sobre refacciones cerámicas comunícate al Departamento Oficina de Refacciones

WC MIURA16 TCC 4.8 LPD

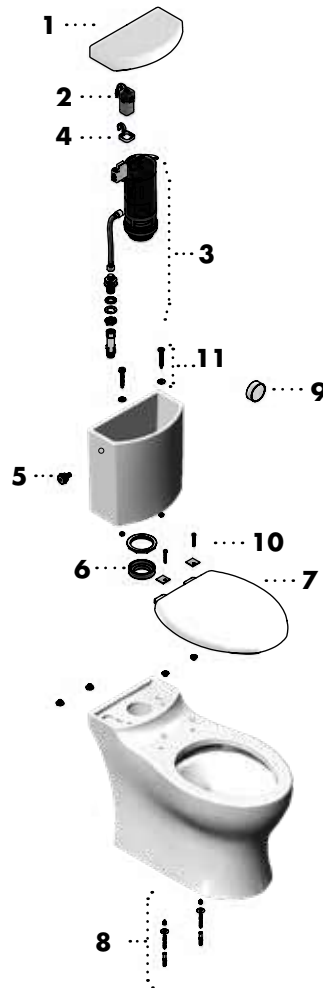

#	Modelo	Descripción
1	SX-RF-1215	Tapa para tanque Miura16 TCC
2	SX-SF-911	Módulo de control
3	SX-SF-912	Kit válvula de descarga
4	SX-RF-1216	Soporte holder
5	SX-SF-913	Botón
6	SX-RF-1010	Empaque esponjoso para WC 3"
7	AT-5	Asiento de cierre lento
8	SX-SF-771	Kit de fijación taza trampa oculta
9	SX-SF-910	Sensor
10	SX-SF-904	Kit de sujeción asiento
11	SX-SF-704	Kit de sujeción para tanque

Para cualquier duda sobre refacciones cerámicas comunícate al Departamento Oficina de Refacciones

OP RIVOLI PLUS 4.8 LPD



#	Modelo	Descripción
1	SX-SF-636	Botón para tapa tanque 4.8 L cromo
2	SX-RF-1024	Tapa tanque OP Rivoli Plus
3	SX-SF-815	Kit de válvula de admisión y válvula de descarga 3"
4	SX-RF-846	Filtro para válvula de admisión para WC
5	SX-SF-771	Kit de fijación taza trampa oculta
6	SX-RF-1004	Empaque de silicón para válvula 3"
7	AT-4	Asiento cierre lento elongado envolvente antibacterial blanco
8	SX-SF-785	Kit de sujeción para asiento AT-4

Para cualquier duda sobre refacciones cerámicas comunícate al Departamento Oficina de Refacciones

OP RIVOLI PLUS T 4.8 LPD

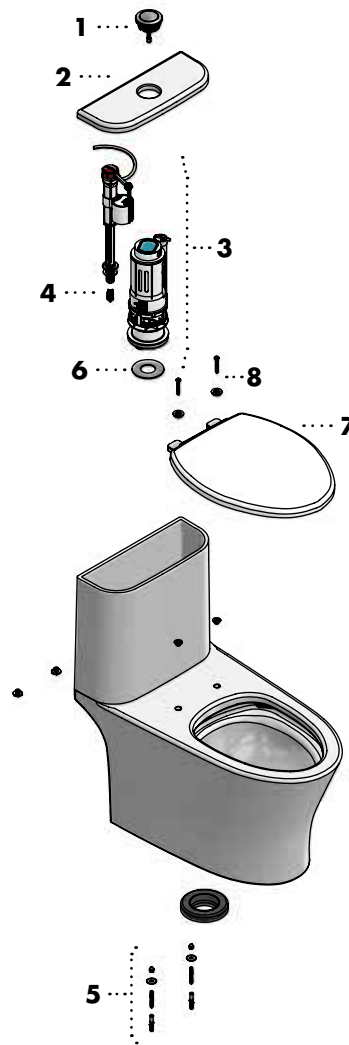

#	Modelo	Descripción
1	SX-SF-636	Botón para tapa tanque 4.8 L cromo
2	SX-RF-1232	Tapa tanque OP Rivoli Plus
3	SX-SF-815	Kit de válvula de admisión y válvula de descarga 3"
4	SX-RF-846	Filtro para válvula de admisión para WC
5	SX-SF-771	Kit de fijación taza trampa oculta
6	SX-RF-1004	Empaque de silicón para válvula 3"
7	AT-4	Asiento cierre lento elongado envolvente antibacterial blanco
8	SX-SF-785	Kit de sujeción para asiento AT-4

Para cualquier duda sobre refacciones cerámicas comunícate al Departamento Oficina de Refacciones

OP CAPRI PLUS 4.8 LPD

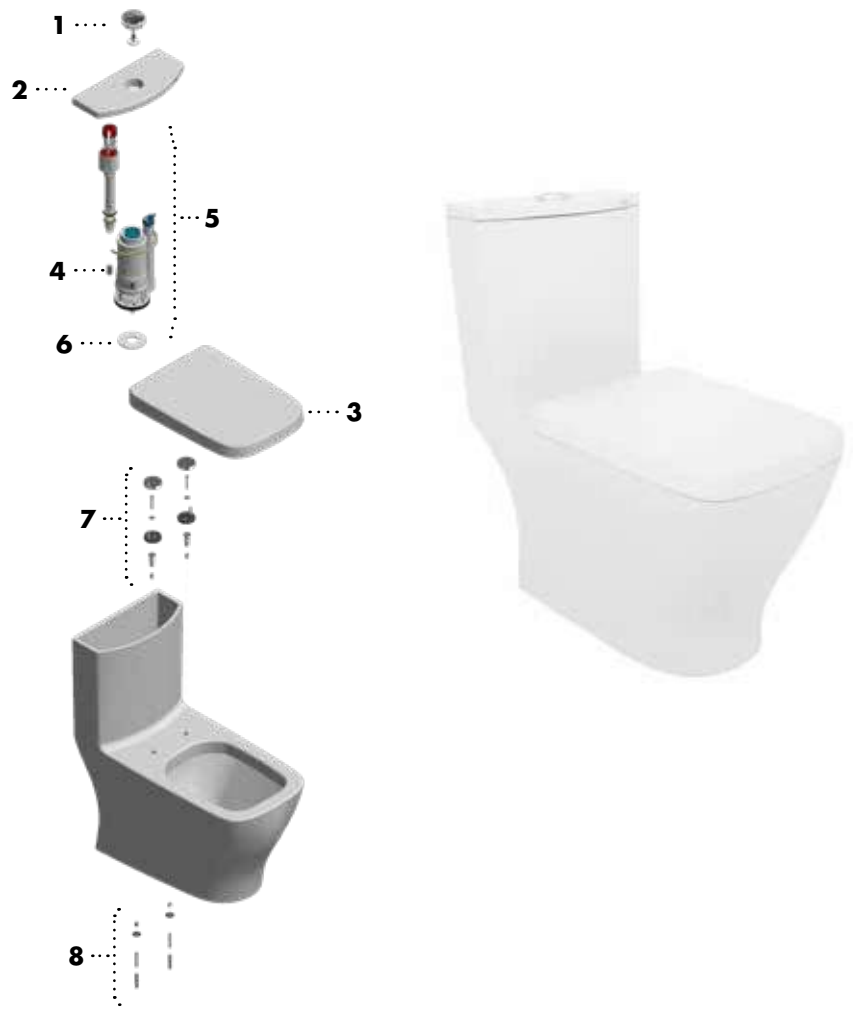

#	Modelo	Descripción
1	SX-SF-636	Botón para tapa tanque 4.8 L cromo
2	SX-RF-1090	Tapa para tanque OP Capri Plus
3	SX-SF-839	Asiento para OP Capri Plus
4	SX-RF-846	Filtro para válvula de admisión para WC
5	SX-SF-842	Kit de válvula para tanque OP Capri Plus
6	SX-RF-1004	Empaque de silicón para válvula 3"
7	SX-SF-840	Kit de sujeción para OP Capri Plus
8	SX-SF-771	Kit de fijación taza trampa oculta

Para cualquier duda sobre refacciones cerámicas comunícate al Departamento Oficina de Refacciones

TZF TAZA NAO PARED

TRAMPA OCULTA 6 LPD, ECOLÓGICO
3.5 LPD, 4.8 LPD

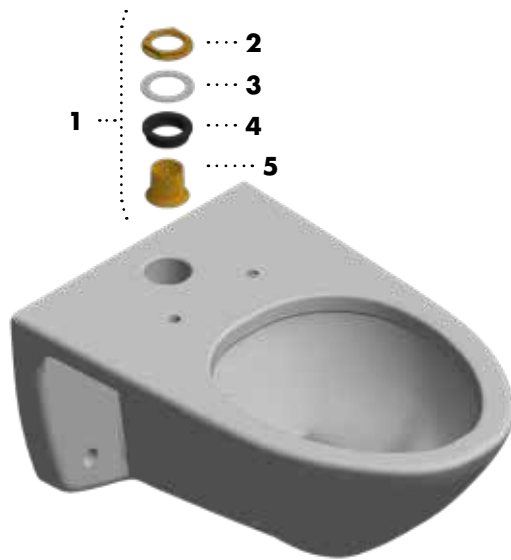

#	Modelo	Descripción
1	SX-SF-648	Spud para taza de 38 mm
2	SX-RF-740	Tuerca plana de WC para fluxómetro spud 38 mm
3	SX-RF-738	Rondana de spud para taza de fluxómetro 38 mm
4	SX-RF-739	Empaque para spud de 38 mm
5	SX-RF-737	Espárrago de WC para fluxómetro spud de 38 mm

Para cualquier duda sobre refacciones cerámicas comunícate al Departamento Oficina de Refacciones

SOPORTE PARA TAZA S-TZF-P

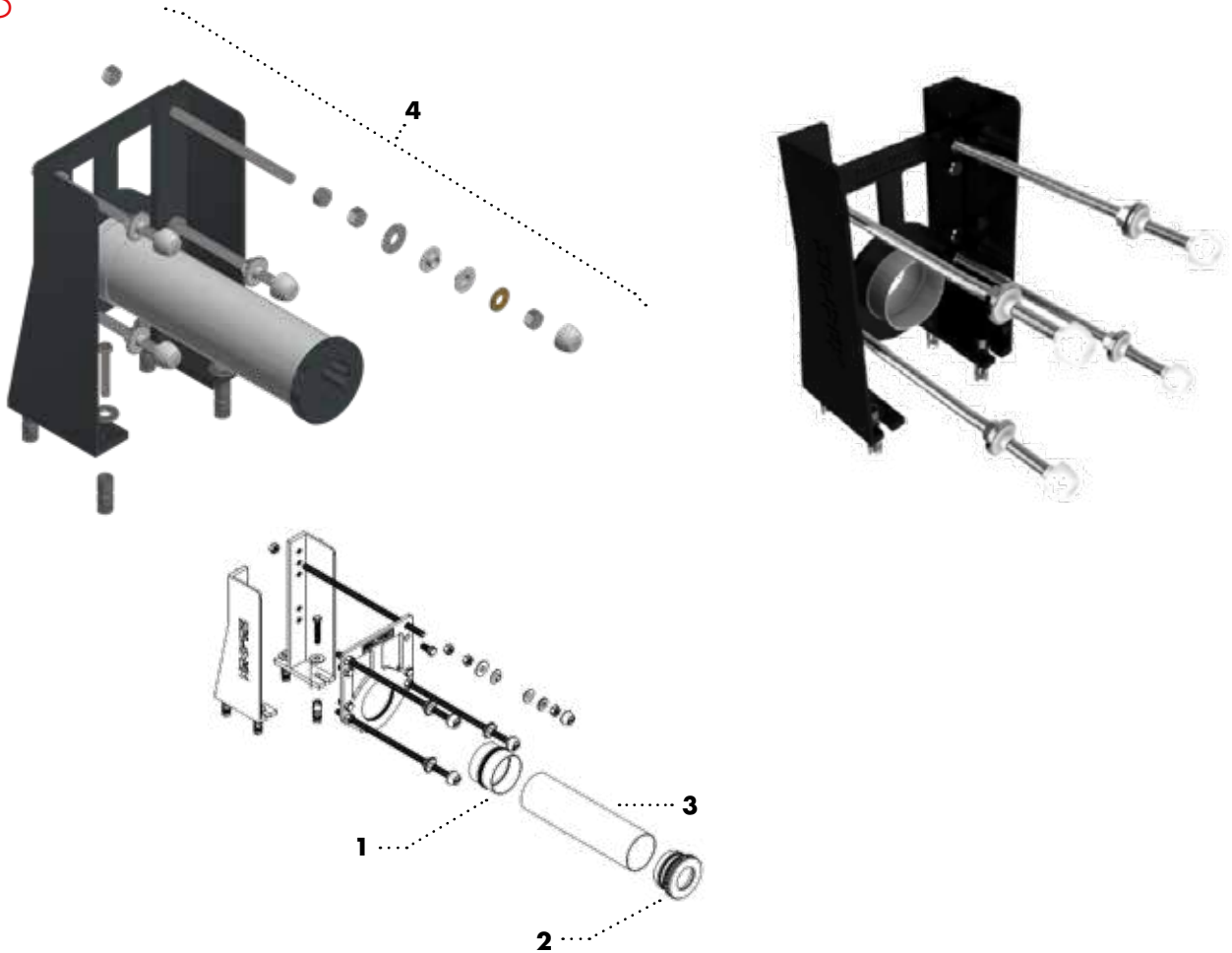

#	Modelo	Descripción
1	SX-RF-967	Cople para taza suspendida 4 3/4"
2	SX-RF-951	Cuello flexible para sanitario 100 mm
3	SX-RF-970	Tubo PVC para cople 4 3/4"
4	SX-SF-798	Juego de tuercas y rondanas para taza suspendida

Para cualquier duda sobre refacciones cerámicas comunícate al Departamento Oficina de Refacciones

TAZA TZF NAO

3.5 LPD / 4.8 LPD



#	Modelo	Descripción
1	SX-SF-648	Spud para taza de 38 mm
2	SX-RF-739	Empaque para spud de 38 mm
3	SX-SF-691	Kit para anclaje WC blanco
4	SX-SF-643	Juego de cubre pijas para WC blanco

Para cualquier duda sobre refacciones cerámicas comunícate al Departamento Oficina de Refacciones

TAZA TZF NAO17

3.5 LPD / 4.8 LPD



#	Modelo	Descripción
1	SX-SF-648	Spud para taza de 38 mm
2	SX-RF-739	Empaque para spud de 38 mm
3	SX-SF-691	Kit para anclaje de WC blanco
4	SX-SF-643	Juego de cubre pijas para WC blanco

Para cualquier duda sobre refacciones cerámicas comunícate al Departamento Oficina de Refacciones

ASIENTOS DE WC

AT-1

ASIENTO Y TAPA DE CIERRE LENTO ELONGADO

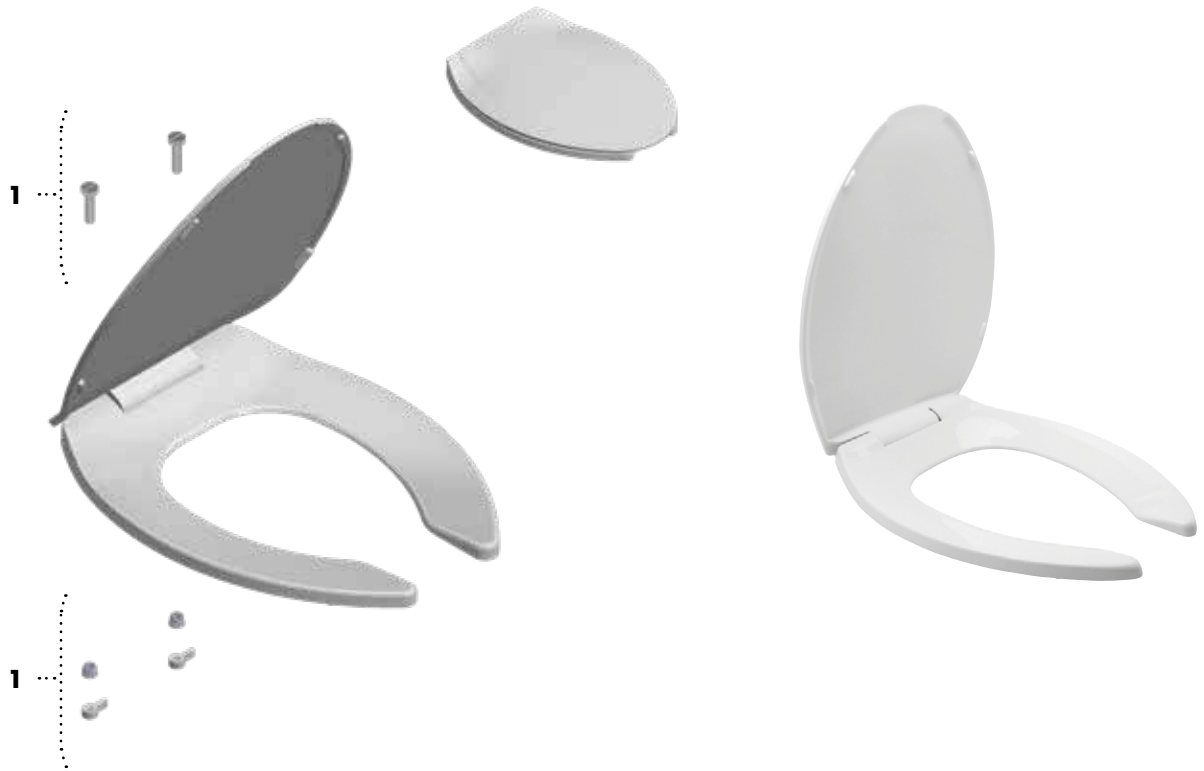

#	Modelo	Descripción
1	SX-SF-734	Kit de sujeción AT-1

Para cualquier duda sobre refacciones cerámicas comunícate al Departamento Oficina de Refacciones

ASIENTOS DE WC

AT-2

ASIENTO CON TAPA DE CIERRE ESTÁNDAR ELONGADO

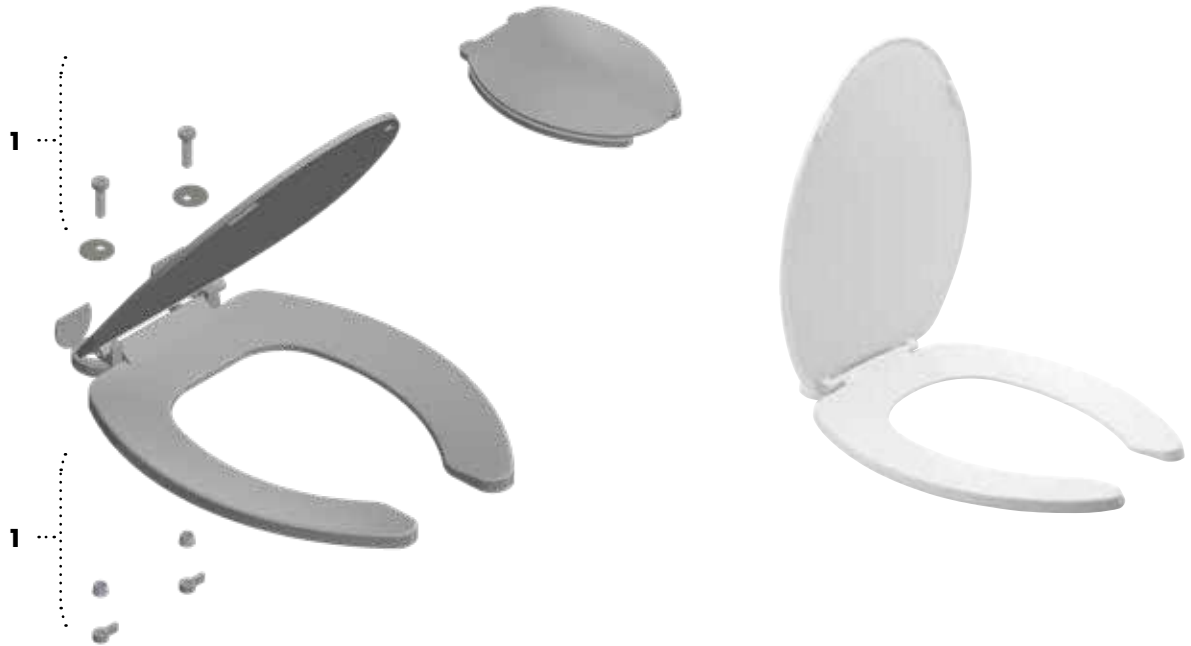

#	Modelo	Descripción
1	SX-SF-735	Kit de sujeción AT-2

Para cualquier duda sobre refacciones cerámicas comunícate al Departamento Oficina de Refacciones

AT-4

ASIENTO CON TAPA ENVOLVENTE DE CIERRE LENTO



#	Modelo	Descripción
1	SX-SF-785	Kit de sujeción para asiento AT-4

Para cualquier duda sobre refacciones cerámicas comunícate al Departamento Oficina de Refacciones

ASIENTOS DE WC

AT-5

ASIENTO CON FRENTE ABIERTO CON TAPA DE CIERRE LENTO

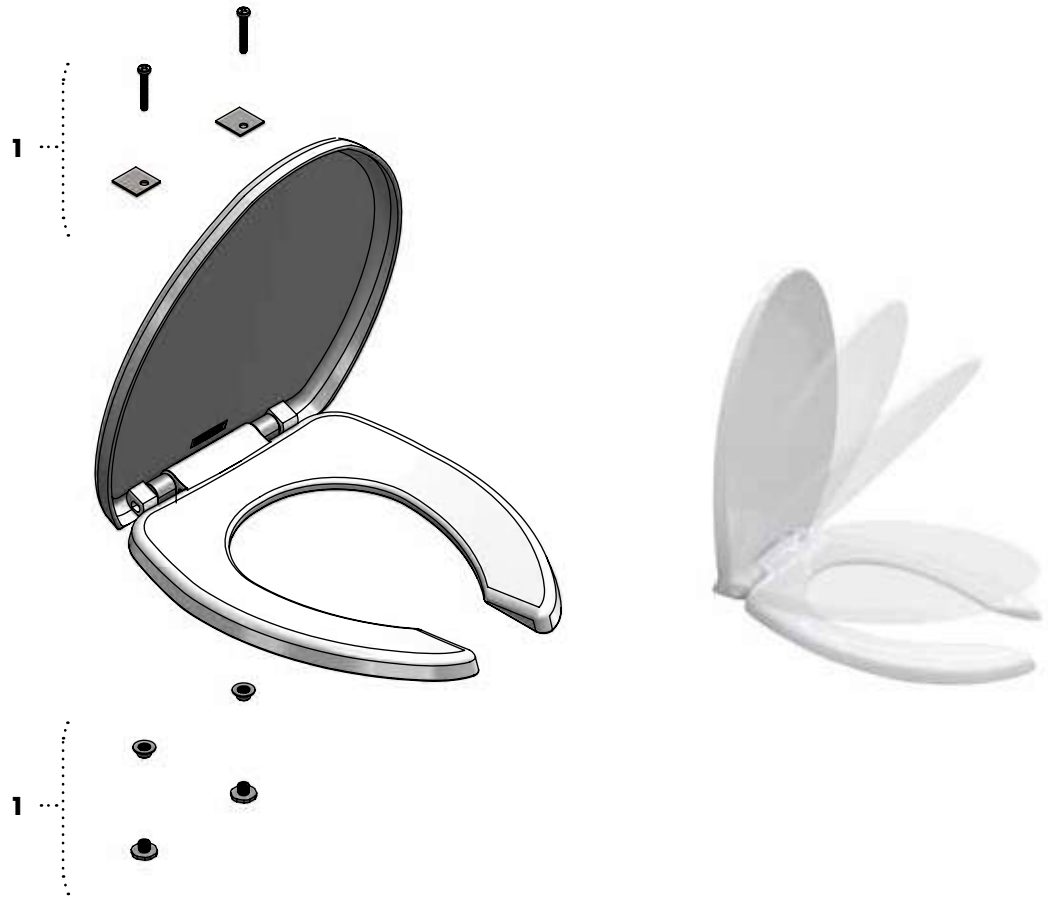

#	Modelo	Descripción
1	SX-SF-904	Kit de sujeción AT-5

Para cualquier duda sobre refacciones cerámicas comunícate al Departamento Oficina de Refacciones

ASIENTOS DE WC

ATM

ASIENTO MECÁNICO CON FUNCIONES TIPO BIDET



#	Modelo	Descripción
1	SB-1247	Kit de sujeción para asiento ATM
2	SB-1250	Manguera para asiento ATE
3	RB-888	Conector para asiento ATM

Para cualquier duda sobre refacciones cerámicas comunícate al Departamento Oficina de Refacciones

ASIENTOS DE WC

ATE

ASIENTO ELECTRÓNICO CON
FUNCIONES DE LIMPIEZA SECADO
Y CALEFACCIÓN



#	Modelo	Descripción
1	RB-889	Conector para asiento ATE
2	SB-1250	Manguera para asiento ATE
3	SB-1248	Kit de empaques para manguera
4	SB-1234	Control remoto

Para cualquier duda sobre refacciones cerámicas comunícate al Departamento Oficina de Refacciones

ATR-1

ASIENTO CON TAPA DE CIERRE ESTÁNDAR

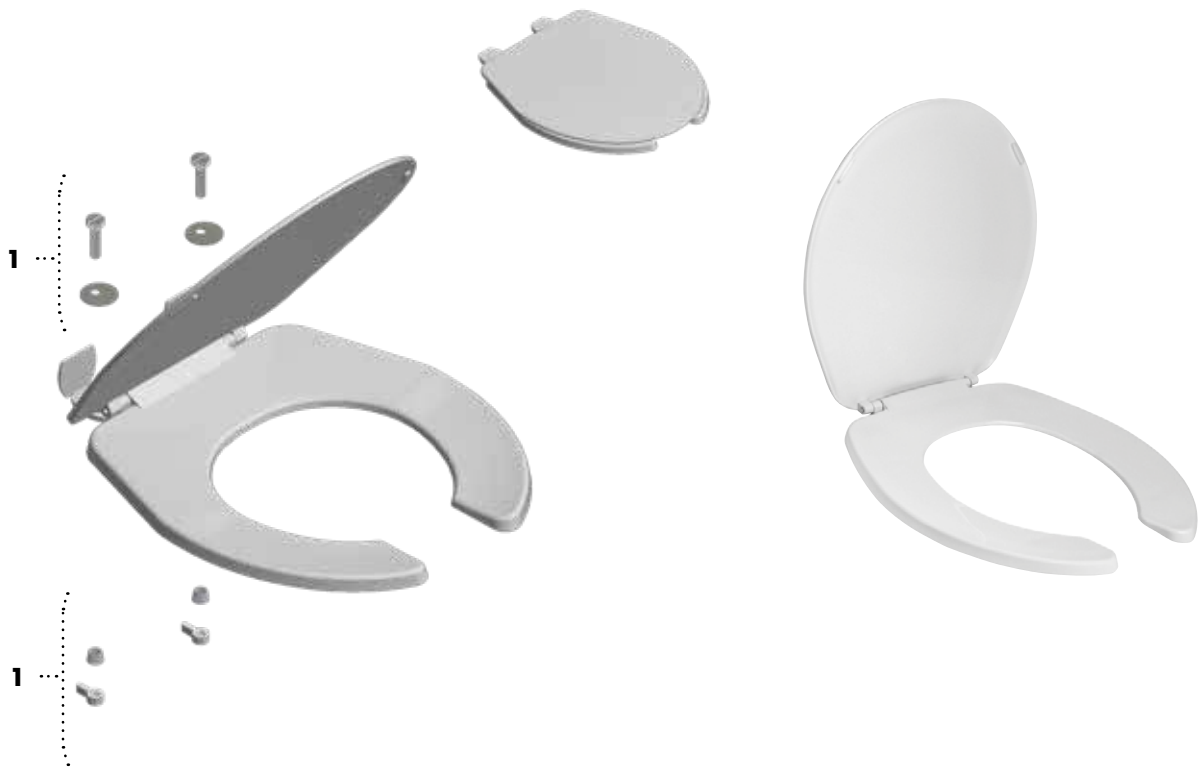

#	Modelo	Descripción
1	SX-SF-735	Kit de sujeción AT-2

Para cualquier duda sobre refacciones cerámicas comunícate al Departamento Oficina de Refacciones

AF-1

ASIENTO SIN TAPA ELONGADO

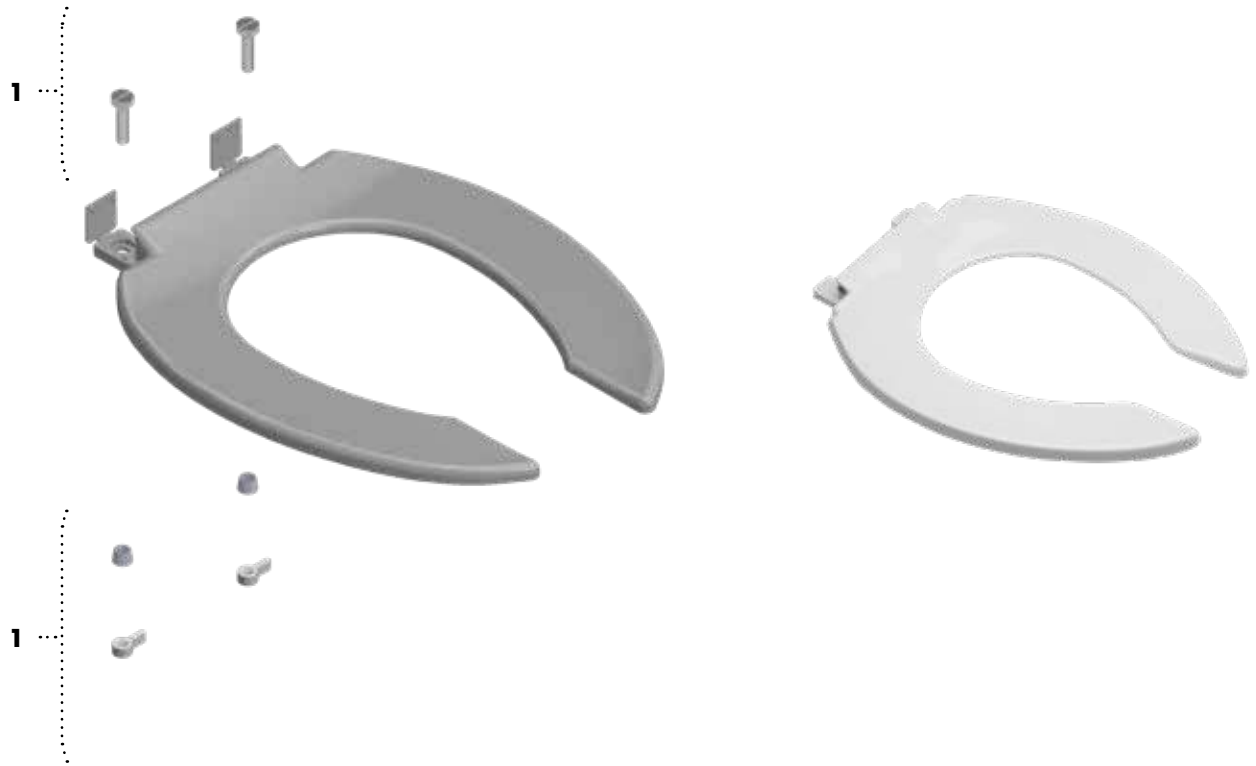

#	Modelo	Descripción
1	SX-SF-734	Kit de sujeción AT-1

Para cualquier duda sobre refacciones cerámicas comunícate al Departamento Oficina de Refacciones

AF-2

ASIENTO SIN TAPA ELONGADO



#	Modelo	Descripción
1	SB-1147	Kit de sujeción asiento AF-2

Para cualquier duda sobre refacciones cerámicas comunícate al Departamento Oficina de Refacciones

LAVABOS

LV FURTURA1

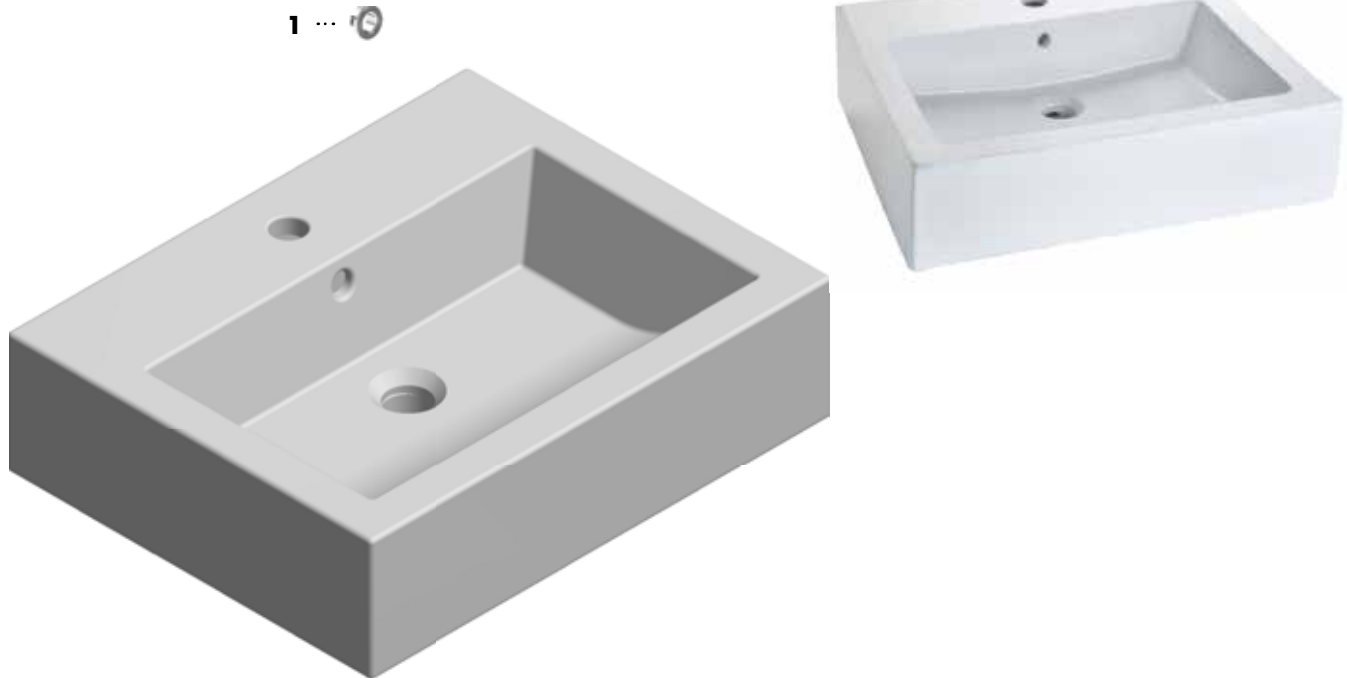

#	Modelo	Descripción
1	SX-RF-1011	Chapetón para Lavabo Futura 1 y 3

Para cualquier duda sobre refacciones cerámicas comunícate al Departamento Oficina de Refacciones

LAVABOS

LV LUCERNA1

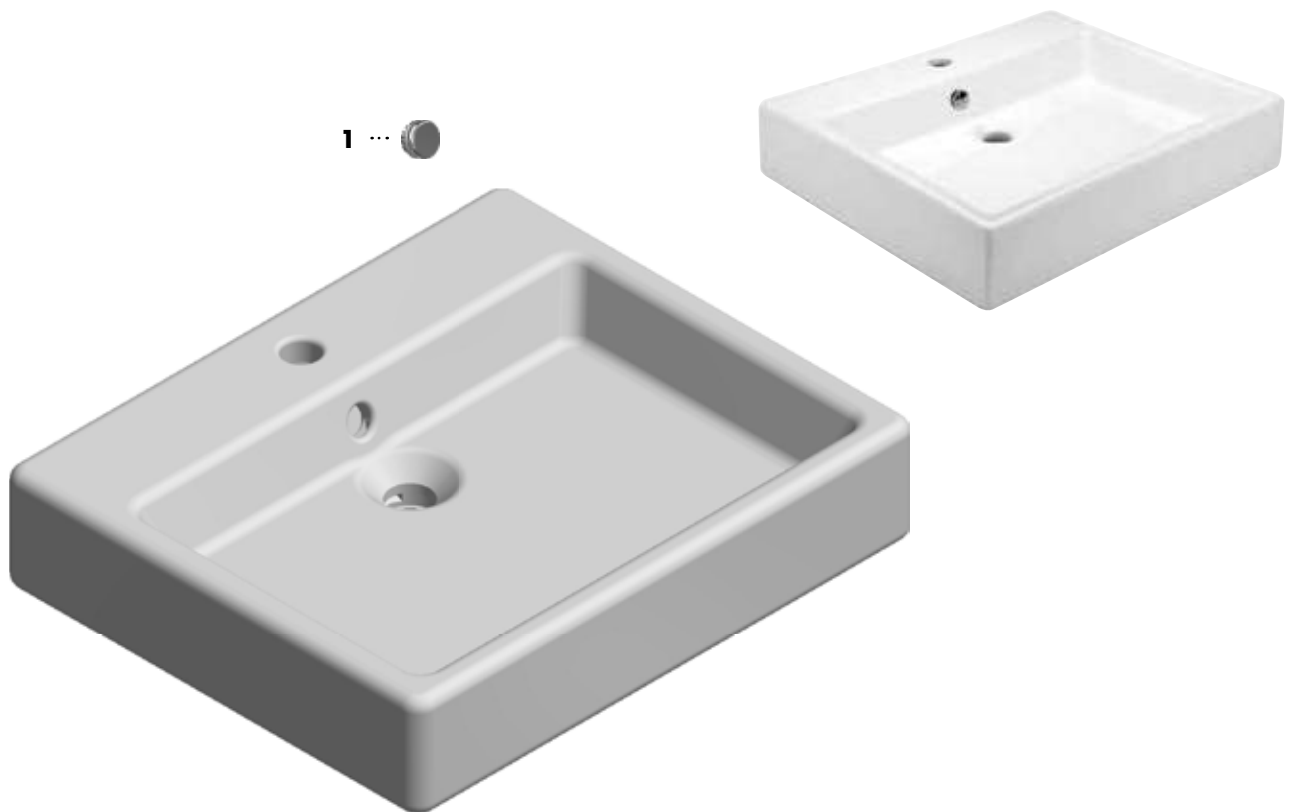

#	Modelo	Descripción
1	SX-RF-898	Chapetón de rebosadero

Para cualquier duda sobre refacciones cerámicas comunícate al Departamento Oficina de Refacciones

LAVABOS

LV LUCERNA3 GDE

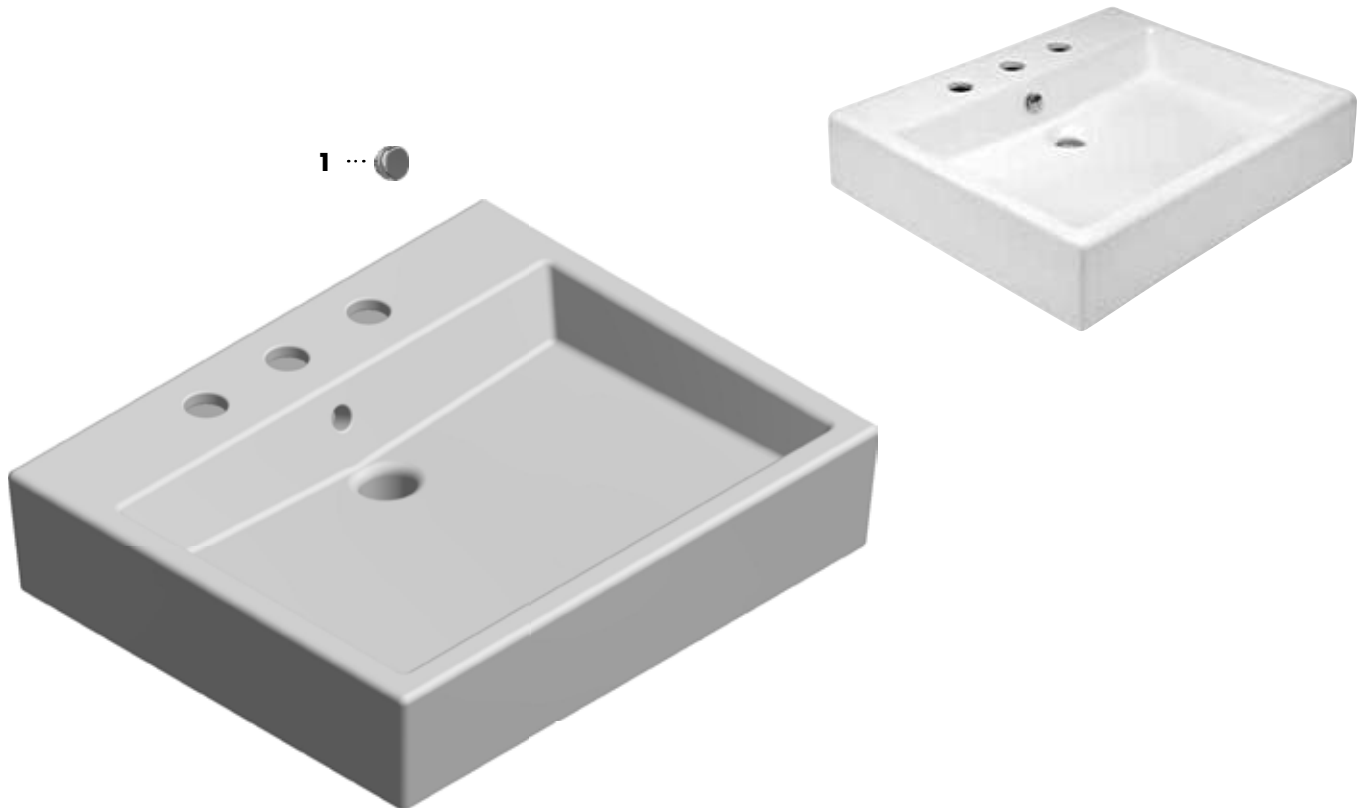

#	Modelo	Descripción
1	SX-RF-898	Chapetón de rebosadero

Para cualquier duda sobre refacciones cerámicas comunícate al Departamento Oficina de Refacciones

LAVABOS

LV SANTORINI1

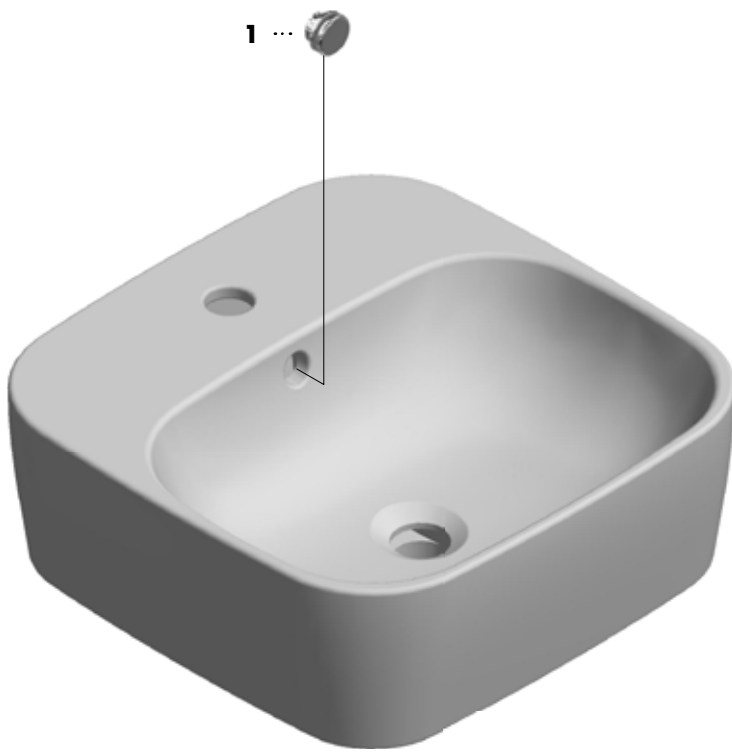

#	Modelo	Descripción
1	SX-RF-898	Chapetón de rebosadero

Para cualquier duda sobre refacciones cerámicas comunícate al Departamento Oficina de Refacciones

LAVABOS

LV MOREA1

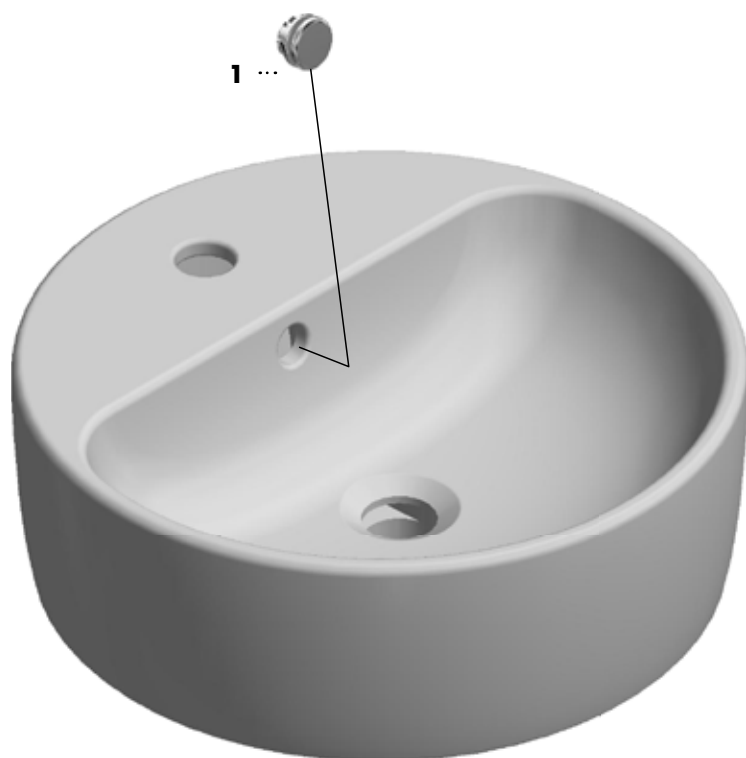

#	Modelo	Descripción
1	SX-RF-898	Chapetón de rebosadero

Para cualquier duda sobre refacciones cerámicas comunícate al Departamento Oficina de Refacciones

LAVABOS

LV MARCUS BC



#	Modelo	Descripción
1	SX-SF-794	Kit de sujeción para lavabo

Para cualquier duda sobre refacciones cerámicas comunícate al Departamento Oficina de Refacciones



BENEFICIOS DEL HOLOGRAMA



Esta zona especial del holograma es **scratch off** rascable con una moneda, revelando un código PIN secreto de 6 dígitos.

Al desplazar el holograma de **izquierda a derecha**, podrás apreciar cómo simula **la rotación del planeta en 3D**



Dependiendo de la posición desde la que lo observes, podrás apreciar diferentes imágenes de manera individual. En un canal, se muestra el texto **'REFACCIONES ORIGINALES'**, y al mover el holograma, se revela otro canal con el texto **'ORIGINAL PARTS'**.

Escanea el código QR
con tu celular para validar
la originalidad de tu refacción y como
medida adicional de seguridad ingresa
el código PIN para confirmar la autenticidad
de la misma.

Tu confianza y tranquilidad son nuestro compromiso.

NUEVO DISEÑO

BLISTER REFACCIONES

HELVEX®

Garantía de Calidad

TU TRANQUILIDAD ES
ELEGIR **REFACCIONES
ORIGINALES HELVEX**

Al adquirir **Refacciones Originales Helvex**,
conservas tu Respaldo y garantías de Helvex



Holograma Helvex



¿TIENES DUDA DE
COMO **CAMBIAR
TU REFACCIÓN?**



**UBICA A TU
DISTRIBUIDOR MÁS
CERCANO**



GUÍA TÉCNICA DE
REFACCIONES

• **CARTUCHOS** • **AIREADORES** • **VALVEX**
ÉMBOLOS • **COLADERAS** • **CERÁMICOS**

Refacciones Originales



garantía de calidad

CARTUCHOS



Cartucho monomando
mantis 35mm Diam.
Vástago plástico
SH-374



Mantiss
EP-92



Cartucho monomando
Barreno pasado 40 mm Diam.
Vástago plástico
SH-373



Productos discontinuados: E-36



Nuva
E-34



Elipsis
E-39



Gourmet
E-305-AAI
E-305



Gourmet Twin
E-308



Cartucho monomando
40 mm Diam.
SV-861

Productos discontinuados:
E-706, E-707

Para versiones anteriores:
SV-645



Vértika
E-700



Vértika
E-701



Premier
E-702



**Premier
Ébano / Cromo**
E-702-EB/CR



Premier ébano
E-702-EB



Premier
E-703



Piura
PIU-200



Piura
PIU-201

CARTUCHOS



Cartucho monomando
GDM Lavabo 35 mm Diam.
SH-370

Productos discontinuados:
E-94, E-95, E-99, E-900
E-71, E-73, E-90, E903-AI
E-931, E-932, E-933, E-25,
E-712, E-3003



Kúbica
EP-3005



Nuva
EP-3003



Nuva
E-32



Explora
E-907



Explora
E-908



Curvo
E-307



Elite
E-300



Aqua
EP-95



Nuva
EP-99



Novara
E-930



Nuva
EP-945



Nuva
EP-947



Kúbica
EP-94



Novus
EP-900



Cartucho ecológico armado
Barreno frontal de 35 mm Diam.
SH-1057



Explora
E-907-CE



Explora
E-908-CE

CARTUCHOS



Cartucho para monomando
40 mm Diam.

SV-860

Productos discontinuados:
E-57, E-58, E-55, E-55-AI,
E-56, E-56-AI, E-83, E-84,



Para modelos anteriores:
SV-365

Para modelo E-713 anterior:
SV-790



Nuva
E-46



Nuva
E-47



Kúbica
E-48



Kúbica
E-49



Explora
E-59



Explora
E-705



Century
E-708



Century
E-709



Squadra
E-710



Squadra
E-711



Máxima
E-713



Squadra
E-710-EB



Cartucho compensador
monomando 40 mm Diam.
Vástago plástico

SV-409

Modelo anterior SV-409-S



Productos discontinuados:
E-761, E-777, E-778, E-773-AAi,
E-774-AAI, E-770, E-771, E-780,
E-781, E-765, E-762, E-775, E-776,
E-784,
E-785, E-790, E-792



Century
E-791



Squadra
E-793

CARTUCHOS



Cartucho para monomando
Barreno pasado de 25 mm
Vástago metálico
SH-1154



Productos discontinuados:
E-918, E-919, E-915, E-910,
E-905, E-909, E-914



Vértika
EP-905



Premier
EP-909



Premier
EP-909-EB



Premier
EP-909-EB/CR



Konos
E-916



Konos
E-917



Scala
E-948



Scala
E-949



Nautilia
E-924



Nautilia
E-925



Squadra
E-929



Álika
E-920



Álika
E-921



Squadra
E-937



Premier
EP-938



Premier
EP-938-EB



Land
E-939



Premier
EP-938-EB/CR



Alba
E-940



Premier II
E-941



E-309



E-310



E-312



Cartucho armado
Lavabo a pared 35 mm Diam.
Vástago plástico
SH-1045



Productos discontinuados:
E-3008, E-3009, E-3010



Kúbica
EP-3007



Cartucho joystick 25 mm Diam.
Vástago metálico
SH-1134

Productos discontinuados:
E-913, E-27



Piura
PIU-100



Piura
PIU-101

CARTUCHOS



Cartucho armado joystick
Lavabo a pared 35 mm Diam.
Vástago metálico
SH-1131

Productos discontinuados: E-3011



Palma
E-306



Cartucho d 35 mm ex35 top
Vástago de plástico
SH-1612

Para versiones anteriores E-933: SH-370
Para versiones anteriores E-928: SH-1154



Century
E-928



Máxima
EP-932



Máxima
EP-933



Lusitania
LUS-100



Lusitania
LUS-101



Piazza
PIA-101



Piazza
PIA-100



Cartucho kx d 35 mm
Vástago de plástico
SV-806

Para versiones anteriores
E-72, E-77, E-714, E-45: SH-370
Para versiones anteriores
PIA-200: SV-798
Segunda versión E-712: SH-1569



Novus
E-45



Mantiss
E-72



Aqua
E-77



Máxima
E-712



Nautilia
E-714



Lusitania
LUS-200



Piazza
PIA-200

CARTUCHOS



Cartucho rotativo der 28 mm
Vástago metálico
SH-1308



Bamboo
E-922



Bamboo
E-922-EB



Bamboo
E-922-EB/CR



Bamboo
E-922-B



Bamboo
E-923



Bamboo
E-923-EB



Bamboo
E-923-EB/CR



Bamboo
E-923-B



Cartucho rotativo 28 mm
Vástago metálico
SH-1598



Indus
E-950-EB



Indus
E-951-EB

ÉMBOLOS PARA MINGITORIO



Émbolo Autolimpieza
SF-774 3 LT

Modelo Anterior
SF-100 Mecánico
SF-171 Electrónico

Descontinuados:
285-19, 410-19



153-19



185-19



310-19



323-19



FB-185-19



FC-185-19



Émbolo Autolimpieza
SF-743 1 LT

Modelo Anterior
SF-651

Descontinuados:
285-19-1, 410-19-1



185-19-1



310-19-1



323-19-1



FB-185-19-1



FC-185-19-1



Émbolo Autolimpieza
SF-744 0.5 LT

Modelo Anterior
SF-600

Descontinuados:
285-19-0.5, 410-19-0.5



153-19-0.5



185-19-0.5



310-19-0.5



323-19-0.5



FB-185-19-0.5



FC-185-19-0.5

ÉMBOLOS PARA WC



Émbolo Autolimpieza **SF-719 6 LT**

Modelo Anterior
SF-124 Mecánico
SF-170 Electrónico

Descontinuados:
110-32, 120-32, 150-32, 152-32,
310-32, 311-32, 312-32, 210-32,
FB-110-32, FC-110-32, 410-32
210-38



Émbolo Autolimpieza **SF-741 4.8 LT**

Modelo Anterior
SF-591

Descontinuados:
210-WC-4.8



ÉMBOLOS PARA WC



Émbolo Autolimpieza
SF-804 3.5 LT

Descontinuados:
210-38-3.5



110-38-3.5



FC-110-38-3.5



310-38-3.5



FB-110-38-3.5



FCO110-38-3.5

VALVEX



Val -Vex V
Grande Izq. cierre de
disco cerámico
SH-1114

Val -Vex V Der.
cierre de disco
cerámico
SH-1012

Modelo Anterior
SH-265



Nuva
MEP-2006



Premier
MEP-2115



Konos
M-1004



Clásica
M-1005



De hospital
H-13341G



Nautilia
M-1006



*E-40-II
*E-40-AQ



E-50-II
E-50-AQ



E-60-II
E-60-AQ



E-61-II / E-61-S
E-61-AQ



Premier
ME-303



Premier
ME-304

Productos discontinuados:

E-301, E-302, E-303, E-2007, E-2111-II, E-2113, E-2117, E-9, E6-II, M-03, E-2001, E-2004-II, E-2009-II,
E-2114, E-2116, E-2118, E-2119, E-2120, MEV6-V, E-2121, E-2122, E-3000, E-3004, E-2115, M-05,
E-2118-DX, ME-2122-1.9

***Nota: El val-vex central del E-40-II, E-40-AQ, corresponde al SH -264**



Val -Vex Der.
Cierre de disco
cerámico
SH-1012

Ambos manerales



Tritón
ME-302



De hospital
VCG-2



Tritón
VCG-2T

VALVEX



Val -Vex I Grande
Izq. mecanismo de
casquillo
SH-262



Iguazú
MEP-2004



E-60



*E-40



E-50

***Nota: El val-vex central del E-40, corresponde al SH -264**



Val -Vex I Grande
der. mecanismo de
casquillo
SH-264



*E-40



*E-40-II



*E-40-AQ

***Nota: Este modelo es sólo para el valvex central**



Val -Vex izq
p/mezcl. Vertika
SH-978



Vértika
MP-1000



Vértika
MR-1001

Val -Vex Der.
p/mezcl. Vertika
SH-979

Productos discontinuados:
M-1001, M-1002, M-1001-DX,
M-1002-DX, M-1003, MR-1003,
MR-1004



Val -Vex II
grande
SH-265

Ambos manerales



Vértika
MR-1005

VALVEX



Val -Vex II Chico
cierre de disco
cerámico
SH-1343 Izq.
SH-1344 Der.

Productos discontinuados:
E-100, E-101-S/C, E-2500,
E-304, HM-15,



Albatros
HM-17



Albatros
HM-37



Flamingo
HM-38

Nota: Para modelos anteriores del 2016, aplica el Val-Vex II Mod. SH-257.



Val -Vex II Chico
Chico der. cierre de
disco cerámico
SH-1344

Productos discontinuados:
HM-16, HM-20

Ambos manerales



Antares
HM-14



Acaya
HM-22



Ática
HM-21



Ántea
HM-18

Nota: Para modelos anteriores del 2016, aplica el Val-Vex II Mod. SH-257.



Val -Vex I Chico
mecanismo de
casquillo
SH-263

Ambos manerales



Elite
MI-01-S/C



Val -Vex II-A
SH-1377 izq.
SH-1376 der.



MI-02-S/C
Primma

Nota:
Para modelos anteriores del 2016, aplica el Val-Vex II Mod. SH-257.

AIREADORES



Aireador Activ.
sin seguro
flujo abierto
SH-282

Productos discontinuados:
E-919, E-100, E-101-S/C, E-2,
E-931, HM-15, E-2-II, E-2001,
EP-2001, HM-16, HM-20,
M-03, E-2117, E-2111, TV-299,
TV-399, E-2112, E-900, EP-
900, TV-401, TV-402, E-90,
EP-2009, E-2115, ME-5,
ME-6, E-918, EP-92, EP-95,
VP-1



Nuva
E-32



Novus
E-34



Explora
E-907
E-907-CE



Explora
E-908



Explora
E-908-CE



Century
E-928



Squadra
E-929



Squadra
E-937



Novara
E-930



Máxima
EP-932



Máxima
EP-933



Century
E-943



De hospital
H-13341G



Albatros
HM-17



Antea
HM-18



Acaya
HM-22



Elite
MI-01-S/C



Primma
MI-02-S/C



Premier
MEP-2115



Argos
TV-296
TV-296-C



Alfa
TV-297
TV-297-C



Omega
TV-298, TV-298-C



Forza
TV-304

AIREADORES COMPATIBLES PARA AHORRO DE AGUA

SH-855 8.3 lts/min

x Pieza



SB-1020 5.7 lts/min

x Pieza



SV-869 1.9 lts/min

x Pieza



SB-1014 5.67 lts/min

Kit de 5 piezas



Compatibilidad: Se requiere mínimo 1 kg de presión

AIREADORES



Aireador para llave economizadora 8.3 lts/min
SH-855



TV-122



TV-203
TV-203-C

Productos discontinuados:
TV-120, TV-203-125EG

AIREADORES COMPATIBLES PARA AHORRO DE AGUA

SH-282

x Pieza

Flujo abierto



SB-1020 5.67 lts/min

x Pieza



SV-869 1.9 lts/min
SPRAY

x Pieza



SB-1014 5.67 lts/min

Kit de 5 piezas



Compatibilidad: Se requiere mínimo 1 kg de presión



Aireador oculto M24
x 1G STD 8.3 lts/min
SH-1135



TV-121

AIREADORES COMPATIBLES PARA AHORRO DE AGUA



SH-1112 flujo libre

x Pieza



SV-605 1.9 lts/min
spray oculto

x Pieza



RH-2197
Llave aireador

Compatibilidad: Se requiere mínimo 1 kg de presión

AIREADORES



Aireador para salida
Nuva
RH-1393



Kúbica
EP-94



Nuva
EP-99



Elite
E-300



Gourmet Twin
E-308



Electrónica
TV-305



Clásica
E-917



Nuva
EP-945



Nuva
EP-947



Nuva
EP-3003

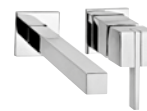

Kúbica
EP-3005



Antares
HM-14



Ática
HM-21



Albatros
HM-37



Flamingos
HM-38



Clásica
M-1005



Tritón
ME-302



Nuva
MEP-2006



Nuva
TV-200



Nimbus
TV-190



De hospital
VCG-2



Tritón
VCG-2T

Productos discontinuados:

E-2113, E-2114, EP-2114, E-2116, EP-2116, E-2500, E-3004, E-301, E-302, E-303, E-304, E-904, M-05, VCG-2T, TV-201, TV-405, TV-400

AIREADORES COMPATIBLES PARA AHORRO DE AGUA

SH-1176 6 lts/min

1 pza



RH-1551 8.31 lts/min

1 pza



SV-604 1.9 lts/min

X pieza



RH-1395 Llave aireador

Compatibilidad: Se requiere mínimo 1 kg de presión

SB-1013 8.31 lts/min

Kit de 5 pzas



AIREADORES



Aireador rectangular
PL-RC 32 x 8 IT
SH-1143

Productos discontinuados:
E-3009, E-905



Vértika
EP-905



RH-2223
Llave aireador



Aireador rectangular
monomando Vértika
SH-1122

Productos discontinuados:
E-3010, E-3010-DX, M-1000, TV-403



Vértika
EP-3007



Vértika
EP-3007-EB



RH-2223
Llave aireador

AIREADORES



Aireador oculto slim
SH-1254



Aireadores compatibles para ahorro de agua

SH-1329 6 lts/min



RH-2736
Llave aireador

AIREADORES



Aireador oculto slim
SH-1587



Lusitania
LUS-100



Lusitania
LUS-101



Piazza
PIA-100



Piazza
PIA-101



Aireador oculto slim
SV-590

Productos discontinuados:
ME-2121, ME-2122,
TV-080, M-1009



Konos
E-916



Konos
M-1004



RH-2197
Llave aireador



Aireador 6 lpm
para monomando
SH-1329

Productos modelos anteriores:
SH-1558

Productos discontinuados:
M-1008



Scala
E-948



Scala
E-948-EB



Scala
E-949



Scala
E-949-EB



RH-2736
Llave aireador

ECONOMIZADORES DE REGADERA



Economizador
6 lts / min
SB-1016

Kit 1 pza

Productos
descontinuados:
H-200-S/BCH, AC110-6



Chorro fijo
H100-6



Óptima
H200-6



Explora
H201-6



Chorro fijo
H500-6



Premier
H3005-6



Kúbica
H3006-6



Nuva
RM22-6

Compatible con los siguientes economizadores



SR-080

Economizador
10 lts/min
1 pza



SR-169

Economizador
E-US TYPE 2.00
GPM 7.6 lts/min
1 pza



SB-1010

Kit de 5pzas
Economizador
para reg
5.6 lts/min



Economizador E-US
2.0 gpm
(7.6 lts/min)
SR-169

Kit 1 pza



Antirrobo
AC110-8



Chorro fijo
H500-8

Compatible con los siguientes economizadores



SR-080

Economizador
10 lts/min
1 pza



SB-1016

Economizador
6lts/min
kit 1 pza



SB-1010

Kit de 5pzas
Economizador
para reg
5.6 lts/min

Productos
descontinuados:
AC20-8, AC30-8, AC50-8

ECONOMIZADORES DE REGADERA



Economizador 10
lts / min
SR-080
Kit 1 pza



Limpieza automática
AC10-TR011



Limpieza automática
AC-110



Limpieza automática
AC20-TR011



Limpieza automática
AC50-TR011



Chorro fijo
AC50-TR011



Chorro fijo
H-500



Chorro fijo
H-600



Konos
H-102



Chorro fijo
H-105



Óptima
H-200



Explora
H-201



Iguazú
H-202



Premier
H-3005



Kúbica
H-3006



Nuva
H-900



Vértika
H-904



Chorro regulable
H1000-TR011



Kúbica
H-3002



Chorro fijo
H-3007



Futura II
RM-17



Nuva
RM-22



Vértika
RM-13



Nuva
RM12-H101



Manual
RM-14



Antigua
RM-5



Futura
RM-7

Compatible con los siguientes economizadores

Productos

descontinuados:

AC-110, AC-20, AC-30, AC-50, H-104, H-106, H-300, H-400, H-800, H-1000, H-2000, H-3001, H-103, H-905, H-901, RM-11, H-700, RM-8, RM-10, RM-12



SR-169

Economizador E-US 2.0 gpm (7.6 lts/min) 1 pza



SB-1016

Economizador 6 lts/ min 1 pzas



SB-1010

Kit de 5pzas Economizador para reg 5.6 lts/min

COLADERAS DE REJILLA Y CÚPULAS



RC-011 Rejilla de contra



282-H



1342-H

Puede convertirse a ciega con el modelo:



RC-018



Tornillo niquelado No.10 **RC-012**



RC-033 Tapa ciega



26

Puede convertirse a desagüe con el modelo:



RC-020



Tornillo niquelado No.10 **RC-012**



RC-020 Rejilla de contra



27



28



24



25



342-R



Puede convertirse a ciega con el modelo:

RC-033



Tornillo niquelado No.10 **RC-012**

COLADERAS DE REJILLA Y CÚPULAS



RC-100

Rejilla cuadrada



Puede convertirse a ciega con el modelo: **RC-134**



Tornillo niquelado No.10
RC-012



24-CH



25-CH



342-C



RC-037

Rejilla cuadrada



Puede convertirse a ciega con el modelo: **RC-074**



Tornillo niquelado No.10
RC-012



282-35-CH



1342-35CH



RC-104

Cúpula p/contra coladera



24-HL



25-HL



24-CHL



25-CHL

COLADERAS, CÚPULAS Y PORTA INCERTO



RC-143

Porta inserto redondo



22-HLI



22V-HLI



24-HLI



25-HLI



RC-162

Porta inserto cuadro chico

Para modelos anteriores
24-CHLI y 25-CHLI: SC-042



22V-CHLI



22-CHLI



24-CHLI



25-CHLI



RC-110

Cúpula p/contra coladera



282-35-CHL



1342-35-CHL



RC-145

Cúpula redonda grande



282-HLI



1342-HLI



RC-108

Cúpula p/contra coladera



282-HL



1342-HL

COLADERAS CÚPULAS Y REJILLAS



RC-165

Porta inserto cuadro grande

Para modelos anteriores
SC-043



282-35-CHLI



1342-35-CHLI



RC-073

Cúpula de coladera



444



444-X



RC-078

Cúpula de coladera



446-X



RC-030

Rejilla rectangular



2714



RC-027

Rejilla coladera



2514

COLADERAS CORTAS, SOPORTES Y TORNILLOS



RC-253

Soporte para cúpula



22V-HLI



22V-HL



22V-CHL



22-HLI



22-CHL



22-HL



RC-252

Tornillo cónico 8-32



22V-HLI



22V-HL



22V-CHL



22-HLI



22-CHL



22-HL

EMBUDOS Y COLADERAS CORTAS



RC-241

Embudo coladera



22



22-CH



22V



22V-CH



22-CHLI



22-HLI



22V-CHLI



22V-HLI



22-HL



22-CHL



22V-HL



22V-CHL



RC-240

Vaso para coladeras cortas



22



22-CH



22V



22V-CH



22-CHLI



22-HLI



22V-CHLI



22V-HLI



22-HL



22-CHL



22V-HL



22V-CHL

COLADERAS DE REJILLA Y CÚPULAS



RC-148

Cúpula p/rebosadero



342-CL



342-RL



RC-062

Rejilla contra coladera



632-H



Tornillo niquelado
RC-054



RC-043

Rejilla para coladera



4954



RC-009

Rejilla para canasta



5424



RC-048

Rejilla ciega
con casquillo



2584

SC-008

Rejilla con
marco

CASQUILLOS



RC-016

Casquillo contra grande



1342-35CH



282-35-CHLI



282-H



1342-H



282-35CH



1342-35-CHLI



RC-024

Casquillo para coladera



27



28



RC-032

Casquillo contra chica



25



24-CHLI



24



24-CH



25-CH



26



25-CHLI

CASQUILLOS



RC-106

Casquillo contra grande



24-HLI



24-HL



24-CHL



25-CHL



25-HL



25-HLI



RC-111

Casquillo grande



1342-HL



1342-HLI



282-HLI



282-HL



282-35-CHL



1342-35-CHL

CONTRAS ARMADAS



SC-011

Rejilla con casquillo para coladera



1342-H



282-H



SC-016

Rejilla con casquillo para coladera



24



25



SC-020

Rejilla ciega para coladera con casquillo



26



SC-021

Contra armada redonda lisa chica.



24-HL



25-HL



SC-022

Contra armada cuadrada lisa chica.



24-CHL



25-CHL



SC-035

Contra armada cuadrada lisa chica.



25-CH



24-CH

CONTRAS ARMADAS



SC-023

Contra armada redonda
lisa grande



282-HL



1342-HL



SC-024

Rejilla con casquillo
para coladera



27



28



SC-028

Rejilla Acero Inoxidable
con casquillo



282-35CH



1342-35CH



SC-036

Contra armada
para coladera



24-HLI



25-HLI



SC-037

Contra armada
redonda para coladera



282-HLI



1342-HLI

CONTRAS ARMADAS



SC-040

Contra armada para coladera



24-CHLI



25-CHLI



SC-041

Contra armada cuadrada para coladera



282-35-CHLI



1342-35-CHLI



SC-025

Contra armada lisa cuadrada grande



282-35-CHL



1342-35-CHL



SC-049

Contra armada para coladera



24-RHLI



SC-064

Contra armada para coladera



24-RHLI-60



SC-066

Contra armada para coladera



24-RHLI-90

CONTRAS ARMADAS COLADERAS CORTAS



SC-074

Contra armada rejilla



22V



22



SC-075

Contra armada
rejilla cuadrada



22V-CH



22-CH



SC-076

Contra armada
de una boca redonda



22-CHL



22V-CHL



SC-077

Contra para inserto
cuadrado



22V-CHLI



22-CHLI



SC-078

Contra armada
de boca redonda



22-HL



22V-HL



SC-079

Contra armada de boca
inserto redondo



22V-HLI



22-HLI

BOTONES PARA WC



Botón SX-SF-636



OP RIVOLI PLUS
4.8



OP CAPRI PLUS
4.8



WC MURANO
4.8



WC MIURA
4.8



WC BOLMEN
4.8



WC RÓDANO
4.8



WC DRAKAR
4.8 / 16



WC OLIMPIA
3.8



WC OPTION
4.8



WC BOLMEN16
4.8



WC RODANO16
4.8



WC AUSTRAL
4.8



WC 2.5
4.8



WC MIURA 16
4.8



OP CAPRI PLUS
4.8



Botón SX-SF-637



WC BOLMEN2
doble descarga



WC RODANO2
doble descarga



WC DRAKAR2
doble descarga



Botón SX-SF-913



MIURA16 TCC

TAPAS PARA TANQUE WC



SX-RF-1020



WC MURANO 4.8



SX-RF-1024



OP RIVOLI PLUS 4.8



SX-RF-1079



**WC MIURA 4.8
WC MIURA 16**



SX-RF-1090



OP CAPRI PLUS 4.8



SX-RF-831



**WC DRAKAR 4.8
WC DRAKAR 2**



SX-RF-832



**WC RODANO 4.8
WC RODANO 2
WC RODANO 16**



SX-RF-1080



WC OPTION 4.8



SX-RF-872



WC COLIMPIA 3.8



SX-RF-833



**WC BOLMEN 4.8
WC BOLMEN 2
WC BOLMEN 16**



SX-RF-1114



WC DRAKAR 16



SX-RF-1215



WC MIURA 16 TCC



SX-RF-1159



WC AUSTRAL P



SX-RF-1158



WC AUSTRAL



SX-RF-1210



WC 2.5

Nota: Las tapas no incluyen botón.

VÁLVULAS DE DESCARGA



2"

WC BOLMEN 4.8
SX-SF-710
WC BOLMEN 2
SX-SF-711



WC DRAKAR 4.8
SX-SF-634
WC DRAKAR 2
SX-SF-635



WC RÓDANO 4.8
SX-SF-708
WC RÓDANO 2
SX-SF-709



SX-SF-832 3"



WC MIURA 4.8



SX-SF-842 3"



OP CAPRI
PLUS 4.8



SX-SF-815 3"



OP RIVOLI
PLUS 4.8
OP RIVOLI PLUS T



SX-SF-883



WC AUSTRALP
4.8



SX-SF-912 3"



WC MIURA16 TCC
4.8



SX-SF-942 3"



WC OPTION
4.8



WC DRAKAR 16



WC RÓDANO16



WC OLIMPIA



WC AUSTRAL



WC MURANO



WC BOLMEN16



WC 2.5



WC MIURA16

KITS DE TORNILLOS PARA TAZA



Kit de tornillos para
taza trampa oculta
SX-SF-771



**OP RIVOLI
PLUS 4.8**



**OP CAPRI
PLUS 4.8**



**WC MIURA
WC MIURA16
WC MIURA16 TCC 4.8**



**WC MURANO
4.8**



Kit de tornillos
para taza
SX-SF-691



**WC BOLMEN 1y2
WC BOLMEN16**



**WC RODANO 1y2
WC RODANO16**



**WC DRAKAR16
1y2**



**WC OLIMPIA
3.8**



**WC OPTION
4.8**



**WC AUSTRAL 4.8
WC AUSTRAL P**

Kit de fijación para asientos



Kit de tornillos
para asiento
SX-SF-840



SX-SF-839



Kit de tornillos
para asientos
SX-SF-785

Kit de tornillos
para asiento
SX-SF-904



Kit de asiento
de sujeción
SB-1147



AF-2



AT-4



AT-3



AT-5



Kit de tornillos
para asientos
SX-SF-734



AT-1 / AT-1-M



AF-1



Kit de tornillos
para asientos
SX-SF-735



AT-2



ATR-1 / ATR-1-M

KITS DE TORNILLOS PARA SUJECIÓN DE TANQUE



Kit de tornillos
para sujeción de tanque
SX- SF-704



WC BOLMEN
1,2 y 16



WC RODANO
1, 2 y 16



WC DRAKAR
16, 1 y 2



WC OLIMPIA
3.8



WC OPTION
4.8



WC MURANO
4.8



WC MIURA
WC MIURA16 TCC
4.8



WC AUSTRAL



WC AUSTRAL P

EMPAQUES PARA WC



Empaque esponjoso
para WC 3"
SX- RF-1010



WC DRAKAR
16



WC OLIMPIA
3.8



WC OPTION
4.8



WC MURANO
4.8



WC MIURA
4.8, 16



WC AUSTRAL P
4.8



WC AUSTRAL
4.8



WC MIURA 16 TCC
4.8



WC RODANO 16
4.8



Empaque Silicón 3"
para válvula
SX- RF-1224



WC MURANO
4.8



WC MIURA
4.8



WC DRAKAR
16



WC OLIMPIA
3.8



WC OPTION
4.8



OP RIVOLI PLUS
4.8



OP CAPRI PLUS
4.8



WC BOLMEN 16
4.8



WC AUSTRAL
4.8



WC RÓDANO 16



WC MIURA 16

DISTRIBUIDORES
AUTORIZADOS

REFACCIONES ORIGINALES

Refacciones Originales



garantía de calidad

A NIVEL NACIONAL

AGUASCALIENTES · BAJA CALIFORNIA · BAJA CALIFORNIA SUR · CAMPECHE · CHIAPAS
CHIHUAHUA · CDMX · COAHUILA · COLIMA · DURANGO · ESTADO DE MÉXICO · GUANAJUATO
· GUERRERO · HIDALGO · JALISCO · MICHOACÁN · MORELOS · NAYARIT · NUEVO LEÓN
· OAXACA · PUEBLA · QUERÉTARO · QUINTANA ROO · SAN LUIS POTOSÍ · SINALOA
SONORA · TABASCO · TAMAULIPAS · TLAXCALA · VERACRUZ · YUCATÁN · ZACATECAS



- BAJÍO
- CENTRO
- METROPOLITANA
- NORESTE
- PACÍFICO
- SURESTE



120 PUNTOS DE VENTA A NIVEL NACIONAL.

CDMX Y ÁREA METROPOLITANA

ÁLVARO OBREGÓN · AZCAPOTZALCO · BENITO JUÁREZ · COYOACÁN · CUAUHTÉMOC
· IZTAPALAPA · MIGUEL HIDALGO · VENUSTIANO CARRANZA

NAUCALPAN · NEZAHUALCÓYOTL · TLALNEPANTLA · TOLUCA



15 PUNTOS DE VENTA EN CDMX Y
ÁREA METROPOLITANA.

ESTADO**DISTRIBUIDOR****DIRECCIÓN****TEL****ZONA METROPOLITANA**

CDMX	COMPAÑÍA FERRETERA TLALOC DEL SUR SA. DE C.V	Av. División del Norte No. 2318, Col. Portales sur Del. Benito Juárez C.P. 03300	(55) 56-88-06-33
CDMX	CASA HADID	División del Norte #2318, Col. Portales C.P. 03300	(55) 55-84-11-99
CDMX	RISUHE S.A DE C.V	Rómulo O'Farril No. 466, Bodega 45, Col. Olivar de los Padres, Del. Álvaro Obregón C.P. 01780	(55) 56-58-99-49 (55) 56-58-96-95
CDMX	MUEBLES PARA BAÑO S.A. DE C.V.	Ayuntamiento 46-B 06010 Col. Centro Del Cauhtémoc	(55) 55-12-97-00 (55) 55-21-72-19 (55) 55-21-95-66
CDMX	MUEBLES PARA BAÑO S.A. DE C.V.	Asistencia Publica No. 72, Col. Federal C.P.15700 Venustiano Carranza	(55) 51-33-63-03 ext. 2017, 2020, 2024, 2018
CDMX	EL SURTIDOR DE OBSERVATORIO	Av. Observatorio No 260, Col Daniel Garza C.P. 11830, Del. Miguel Hidalgo	(55) 52-37-03-00 (55) 14-50-90-00
CDMX	EL SURTIDOR DE TULYEHUALCO	Av. Tláhuac 1479 Col. San Nicolás Tolentino C.P. 09850 Del. Iztapalapa	(55) 52-37-03-55 (55) 54-26-61-63
CDMX	LLANO DE LA TORRE	División del Norte 2113 Col. Santa Cruz Atoyac alcaldía Benito Juárez, CP 03310 CDMX	(55) 56 88 14 99 (55) 56 88 20 22
CDMX	GRUPO FERREBAÑOS S.A. DE C.V.	Norte 35, No. 927. Col. Industrial Vallejo, Del. Azcapotzalco, C.P. 02300	(55) 51-18-32-00
CDMX	COMERCIALIZADORA Y FERRETERA SHUMA	Av. División del Norte 2825, Col. del Parque Del. Coyoacán C.P. 04040	(55) 55-49-89-99
CDMX	DISTRIBUIDORA DE REFACCIONES HELVETIA, S.A. De.CV.	Dr. Erazo, No 27-C, Col Doctores, C.P. 06720 Del. Cauhtémoc	(55) 55-88-22-07 (55) 55-88-22-03
CDMX	TECNO BAÑOS S.A. DE C.V	Cetlapatl No. 28 Edif. B-101, Col. San Martín Xochinahuac, Del. Azcapotzalco C.P. 02120	(55) 53-83-96-20 (55) 53-83-71-76
Edo. de Méx.	UNIÓN DE DISTRIBUIDORES MAYORISTAS S.A. DE C.V.	Calle plásticos No 21 K, Col San Francisco Cauhtlalpan, Naucalpan de Juarez C.P. 53569	(55) 55-46-50-97 (55) 55-46-49-30
Edo. de Méx.	EL SURTIDOR DE OBSERVATORIO S.A. DE C.V. TLANEPANTLA	Autopista Mex-Qro. 3069-A Tequesquihuac C.P. 54020, Tlanepantla de baz Edo. de México	(55) 52-37-03-99 (55) 53-90-37-55
Edo. de Méx.	SANIGAR S.A. DE C.V.	Av. Ángel de la Independencia No. 29 2a. Sección, Col. Metropolitana, Nezahualcóyotl, C.P. 57740	(55) 57-65-09-06 (55) 57-65-29-84

ESTADO**DISTRIBUIDOR****DIRECCIÓN****TEL****ZONA CENTRO**

Toluca	MUEBLES PARA BAÑO S.A. DE C.V.	Paseo Tollocan 110 Col. Ampliación Lázaro Cárdenas Toluca, C.P. 50180	(722) 219 5121 (722) 217 5179
Puebla	MUEBLES PARA BAÑO S.A DE C.V.	25 Poniente No 3504, Col. Belisario Dominguez, Puebla Pue. C.P. 72180	(222) 249 7761
Puebla	FERNANDO MORENO MEJIA	25 Poniente No. 717, Col. Insurgentes Chula vista, Puebla, C.P. 72420	(222) 240-94-12 (222) 240-94-21
Puebla	GABINO FERNANDO MORENO DIAZ	27 Poniente No. 510, Col. Chula vista, Puebla Pue. C.P. 72180	(222) 237-63-02
Puebla	ACABADOS SHUMA S.A. DE C.V.	Recta cholula No. 8, Cuautlancingo, Puebla, C.P. 72730, Col. Bello Horizonte	(222) 284-7272 (222) 284-2967
Puebla	FERRETERÍA NORDICA	21 Sur No. 2501 Esq. 25 Poniente, Col. Los volcanes, Puebla Pue. C.P. 72410	(222) 298-3535
Puebla	TUBERIAS DE ORIENTE	Gran Avenida No. 3621, Col. Las cuartillas, Puebla, Pue. C.P. 72050	(222) 122-22-22
Puebla	LLANO DE LA TORRE	27 Sur 25 Y 23 Pte. 2501 Sta. Cruz los angeles 07F Puebla C.P. 72400	(221) 2672 372
Tehuacán, Puebla	BRICOPAT	Calzada Adolfo López Mateos #4215, San Lorenzo Teotipilco C.P. 75855, Tehuacán Puebla,	(238) 382-3561 (238) 328-3238
Querétaro	PLOMERÍA Y CERÁMICA DE QUERÉTARO S.A.DE C.V.	Pról. Corregidora Sur No. 191, Fracc. Balaustradas, Querétaro Qro. C.P. 76070	(442) 213-4401
Querétaro	MUEBLES PARA BAÑO S.A. DE C.V.	Prol. Luis Pasteur Sur, No. 418-A, Col. Valle alameda, Querétaro Qro. C.P. 76040	(442) 212-6559 (442) 214-1950
Querétaro	AZUPISO SA. DE C.V.	Av. 5 de Febrero No. 1606, Col. San Pablo, Querétaro Qro. C.P. 76130	(442) 217-0777
Veracruz	FERNANDO REQUEJO S.A. DE C.V.	Gómez Farias 1186, Col. Flores Magon Centro Veracruz, Veracruz	(229) 932-32-20 (229) 932-36-54
Veracruz	MUEBLES PARA BAÑO S.A. DE C.V.	Miguel Alemán No. 610, Esq. Altamirano, Col. Salvador Diaz Mirón, Ver., Ver. C.P. 91909	(229) 931-3216 (229) 931-3334
Veracruz	TUBERIAS DE ORIENTE	Manuel J Clouthier 6856, Amapolas Veracruz, Veracruz C.P. 91697	(229)-920-34-24
Veracruz	ACEROS Y MATERIALES ALBA	Bldv. Adolfo Ruiz Cortinez, No. 101, Col. Flores Magon, Poza Rica Veracruz, C.P. 93340	(782) 826-30-50 (782) 826-30-40
Guerrero	ISIDRO OVEJAS S.A. DE C.V.	Bldv. de las naciones #37 L. 10, plaza comercial la joya, Col. Granjas del marquez, Acapulco Gro., C.P. 39890	(744) 466-4629
Guerrero	MV SA DE CV	Av. Farallón No 408, Fracc. Farallón del Obispo, Acapulco Gro. C.P. 39690	(744) 469-9020

ESTADO

DISTRIBUIDOR

DIRECCIÓN

TEL

Guerrero	VITROMEX	Av. Ejido 26 calle 4 No. 26 Col. Bellavista C.P. 39550 Acapulco de Juarez.	(744) 156-1535
Guerrero	MUEBLES PARA BAÑO S.A. DE C.V.	Blvd. De las naciones Km. 13.5 Col. La poza, Acapulco Gro. C.P. 39906	(744) 433-2312 (744) 433-2313
Zihuatanejo	URBANA RAMÍREZ ACEVEDO	Av. Morelos S/N Col. Centro, Municipio Zihuatanejo Azueta, C.P. 40880	(755) 55-43430
Oaxaca	DEPÓSITO ELÉCTRICO Y DISTRIBUCIONES DE TUBOS Y CONEXIONES DE OAXACA	Xicoténcatl No. 204, Col. Centro, Oaxaca Oax. C.P. 68000	(951) 514-11-11 (951) 502-13-40
Oaxaca	PRODUCTO MORA S.A. DE C.V.	Bahía de Sta Cruz, No. 109, sector T, Santa María Huatulco, Oaxaca C.P. 70989	(958) 5870-234
Cuatla	MAYORISTAS EN PLOMERIA Y MUEBLES PARA BAÑO S.A. DE C.V.	Defensa del agua y San Martin No. 27, Col. Centro Cuatla Morelos, C.P. 62740	(735) 352-6402 (735) 352-3496
Tlaxcala	FERRETERÍA BAÑOS Y AZULEJOS DE TLAXCALA S.A. DE C.V.	Sucursal vía corta San Pablo Macro, carretera Federal Santa Ana apizaco Km 30+730 C.P. 90600	(246) 46-872-65
Celaya	CASA BLANCA	Av. Tecnológico 680 Col. Las aves Celaya Gto.	(461) 679 3009
San Miguel de Allende	GRUPO FERRETERO DON PEDRO	Carretera San Miguel a Celaya KM 2.4 Poblado de don Diego C.P. 37887 San Miguel de Allende, Gto	(415) 152 1714
Pachuca	LLANO DE LA TORRE	Carr. Cd. Sahagún-Pachuca No. 1350 Col. Las aguilas C.P. 42186 Mineral de Reforma Hidalgo	(771) 689 0136 ext. 115
Morelos	LLANO DE LA TORRE	Paseo Cuauhnauatl KM 3 5 1908 Fracc. Los tarianes Jiutepec Morelos C.P. 62460	(777) 320 0300

ZONA SURESTE

Cancún	EL FLUXÓMETRO DE CANCÚN S.A. DE C.V.	Av. Xel-Ha No. 89 SM-25 Mz 21 Lote 33, Col. Centro, Cancún Quintana Roo, C.P. 77509	(998) 887-1036
Cancún	EL FLUXÓMETRO DE CANCÚN S.A. DE C.V.	Blv. Luis Donaldo Colosio 2000 Local 1 Mz. 3 Lt 17-02 SM-570, Municipio de Benito Juárez, Cancún, Quintana Roo	(998) 889-9950
Cancún	MUEBLES PARA BAÑO S.A. DE C.V.	Av. José López Portillo Lt. 1 Mz. 60 sm 91 Cancún, C.P. 77516	(998) 891-9777
Cancún	MUEBLES PARA BAÑO S.A. DE C.V.	Av. López Portillo Lt. 36 MZ 66 SMZ58 Col Unidad Morelos, Cancún Quinta Roo 77500	(998) 898-8041 (998) 891-9777
Cancún	PLOBAÑOS DEL SUR S.A DE C.V.	Carr. Cancún Aeropuerto Km. 9 central de bodegas Cancún 15 y 16 Col. Alfredo V. Bonfil C.P. 77560	(998) 887-0421 al 24
Cancún	MATERAMA S.A. DE C.V.	Av. López Portillo Lt. 10 Sp M 102 y 61, Del. Benito Juárez, C.P. 77517, Cancún Q. Roo	(998) 893-7905 (998) 893-5212
Cancún	EL NIPLITO	Av. José López Portillo, Super mz. 98, MZ. 51, lote 3, Cancún Quintana Roo C.P. 77500	(938) 382-8165

ESTADO

DISTRIBUIDOR

DIRECCIÓN

TEL

Mérida	CEREBÁ	Calle 59 DX 104 Jacinto Canek No. 381 Mérida C.P. 97230	(999) 945 0003
Mérida	EL NIPLITO	Calle 60 no. 709 C.P. 97000 Col. Centro Mérida Yucatán	(999) 924-3934
Mérida	EL NIPLITO	Anillo Periférico tablaje catastral 13951, entrada en carretera a Dzitya, Mérida Yucatán C.P. 97200	(999) 930-0630
Mérida	MAYOREO CÉRAMICO DE LA PENÍNSULA S.A. DE C.V. (MCP)	Periférico Sur Km 1 No. 461, Col. El Roble, Mérida Yucatán C.P. 97255	(999) 946-0315
Playa del Carmen	EL NIPLITO	Carretera Federal Cancún - Tulum 140 lt. 2 y 3 Municipio Solidaridad, Playa del Carmen Quintana Roo C.P. 77710	(984) 859-3218 (984) 859-3222 (984) 859-3223
Cozumel	EL NIPLITO	65 Av. Sur con primera entre Av. Rosado Salas No. 148 Col. L. pez Mateos, Cozumel, Quintana Roo C.P. 77667	(987) 872-7590 (987)872-7704
Chetumal	EL NIPLITO	Av. Andrés Quintana Roo no. 356, Col. Taxistas, Municipio Othon P. Blanco, Chetumal Quintana Roo C.P. 77037	(983) 285-3078 (983) 285-3079
Valladolid	EL NIPLITO	Calle 42 no. 201 x 45 esquina Valladolid Yucatán C.P. 97780	(985) 856-1751
Campeche	EL NIPLITO	Av. José López Portillo No. 224, San Francisco de Campeche, Campeche. C.P. 24090	(981) 145-1524
Ciudad del carmen	EL NIPLITO	Av. Juárez No. 214 x 35 B, Col. Fatima, Ciudad del Carmen, Campeche. C.P. 24110	(938) 382-8165 (938) 382-7776
Chiapas	MERCANTIL DEL CONSTRUCTOR S.A. DE C.V.	5ta Av. Norte #734 Esq. 7 poniente Col. Barrio Colón C.P. 29000 Tuxtla Gutierrez	(961) 600-2012 (961) 600-2013
Chiapas	MERCANTIL DEL CONSTRUCTOR S.A. DE C.V.	14 Calle Pte. No. 4, Centro, Tapachula Chiapas C.P. 30700	(962) 626-1050 (962) 626-9590
Chiapas	MERPISOS S.A. DE C.V	Periférico Sur Poniente No. 334 C.P. 29060, Col. Santa Elena, Tuxtla Gutierrez Chiapas	(961) 602-9333 (961) 602-9066 (961) 602-9266
Chiapas	MATERIALES DE LOS ALTOS	Juan Sabines Gutiérrez, No. 6, Barrio de San Diego, C.P. 29270. San Cristóbal de las Casas.	(967) 678-4700
Tabasco	COMERCIALIZADORA DE POLVOS Y ACEROS (BOHAUS)	Avenida Niños Heroes No. 107 Col. Atasta, C.P.: 86100, Villahermosa, Tabasco	(993) 131 1995
Tabasco	CERAMAT	Av. Adolfo Ruiz Cortines S/N Col. Atasta C.P. 86100, Villahermosa tabasco	(993) 354 1480

ZONA BAJÍO

Guadalajara	SERVICIO DE REFACCIONES EL FLUXOMETRO S.A. DE C.V.	Av. Niños Héroes No. 2129, Col. Unión Obrera, Guadalajara Jal. C.P. 44150	(333) 616-8639
Guadalajara	REFACCIONARIA FERRETERA S.A. DE C.V.	González Gallo No. 660, Col. San Carlos Sector Reforma, Guadalajara Jal. C.P. 44460	(333) 619-3015 (333) 619-3090

ESTADO**DISTRIBUIDOR****DIRECCIÓN****TEL**

Guadalajara	NUEVA FERRETERA JIMENEZ S.A DE C.V.	Escorza No. 575, Col. Barrera, Zona Centro Guadalajara Jal. C.P. 44150	(333) 825-9412 (333) 826-3232 (333) 825-6818
Guadalajara	ARKIRAMICA S.A DE C.V.	Carretera a Tepic 5324 Las Juntas 48291 Puerto Vallarta, Jalisco	(322) 290-3237
Guadalajara	EL FLUXÓMETRO DE VALLARTA S.A. DE C.V.	Av. Libramiento No. 130-A, Col. Lázaro Cárdenas, Puerto Vallarta Jal. C.P. 48300	(322) 222-4026 (322) 222-4022
Tepic	KURODA PLOMERIA Y AZULEJOS S.A. DE C.V.	Av. Mar egeon no. 1 Col. Simancas Tepic Nayarit	(311) 688 1292
Guanajuato	AGUALUZ S.A. DE C.V.	Bld. Campestre No. 35-loc 2, Col. La Florida, León Guanajuato C.P. 37470	(477) 779-5047 (477) 779-5089
Guanajuato	GALO S.A DE C.V.	Bld. Hidalgo No. 1408, Fraccionamiento Hidalgo C.P. 37220 León Guanajuato	(477) 718-6513 (477) 718-4141 (477) 718-4037
Guanajuato	LIMS S.A DE C.V.	Bld. Campestre No. 35 esq. Bld. Hidalgo, La florida C.P. 37190 León Guanajuato	(477) 170 -2705
Aguascalientes	LA INDUSTRIAL MEXICANA S.A. DE C.V.	Av. De la Convención Sur #1400, esq. Av. Ayuntamiento, Col. Caminero C.P. 20270, Aguascalientes, Ags.	(449) 910-5006
Michoacán	ISIDRO OVEJAS S.A. DE C.V.	Av. Lázaro Cárdenas No. 1191-A, Col. Centro, Morelia Michoacán, C.P. 58150	(443) 317-3043 (443) 334-1091
Michoacán	REMODELA	Calle Gertrudis Boca Negra No. 861, Ventura Puente Morelia	(443) 315-9231
Michoacán	MORALES ACOSTA DANIEL	Libramiento Km. 5.5 Lt. 3, Mz. 2 Col. Independencia C.P. 60950 Lázaro Cárdenas	(753) 532-2977 (753) 537-7123
Zacatecas	EL TRIANGULO SURTIDOR S.A. DE C.V.	Bld. López Mateos 509, Col. Pánfilo Natera, Zacatecas, C.P. 98070	(492) 922-4578 (492) 922-2638 (492) 922-2659
Colima	MODA CERAMICA S.A. DE C.V.	Av. Venustiano Carranza 1745, Col. Residencial Esmeralda, C.P. : 28017, Colima, Colima	(312) 323 7636 (312) 315 2418
Puerto Vallarta	PLOMERIA UNIVERSAL	Av. Francisco Villa no. 385 Col. Olimpica C.P. 48330 Puerto Vallarta	322 223 4702 322 222 0569

Z O N A N O R E S T E

Monterrey	PISOS Y PLOMERIA DEL NORTE S.A. DE C.V.	Av. Madero No. 1046 Poniente, Col. Centro, Monterrey N. L. C.P. 64000	(818) 375-0133 (818) 375-1365
Monterrey	CASA SANITARIOS Y AZULEJOS S.A. DE C.V.	Av. Aarón Saénz No. 1895, Col Sta. María, Monterrey Nvo. León C.P. 64650	(818) 346-1692
Monterrey	BAÑOS Y DECORACIONES S.A DE C.V.	Av. Vasconcelos 390 Ote Col. Del Valle C.P. 66220 San Pedro Garza Garcia N.L.	(818) 3566 940
Monterrey	LEONCIO MEDRANO TORRES	Av. Colón No. 2330 Poniente, Col. Centro, Monterrey Nvo. León, C.P. 64000	(818) 333-0062 (818) 347-5933

ESTADO

DISTRIBUIDOR

DIRECCIÓN

TEL

Monterrey	PLOMERIA GARCIA S.A. DE C.V.	Av. Madero No. 1031 Pte. Esq. Villagrán, Col. Centro, Monterrey N. L. C.P. 64000	(81) 15222 100
Coahuila	VACO Y CONEXIONES S.A. DE C.V.	Urduñola Norte No.250, Esq. Umbol, Col. Centro, Saltillo Coah. C.P. 25000	(844) 410-3808 (844) 410-4744
Coahuila	AZULEJOS BAÑOS Y CONEXIONES S.A. DE C.V.	Matamoros 185 Poniente, Col. Centro, Torreón Coah. C.P. 27000	(871) 716-8660 (871) 716-8663
Coahuila	GRUPO COMERCIAL CASTA O S.A. DE C.V.	Bldv. Guerrero No. 2035 Sur Vistahermosa, Cd. Acuña Coah. C.P. 26200	(877) 772-4121
Tamaulipas	M.N. DEL GOLFO S.A. DE C.V.	Av. De la Industria No. 14320, Col. Laguna de la Puerta, Altamira, C.P. 89603	(833) 230-1414
Tamaulipas	SANITARIOS Y MATERIALES DE MADERO S.A. DE C.V.	Av. Ejercito Mexicano. Esq. 1º de Mayo S/N, Col. Loma del Gallo, Cd. Madero Tamps. C.P. 89460	(833) 210-3030
Tamaulipas	PLOMERÍA FIERRO Y SANITARIOS	Mina oriente #1001, Ciudad Victoria Tamaulipas, C.P. 87000	(834) 316-8525
Durango	MARÍA DEL REFUGIO	Calle Victoria Sur No. 420 Col. Centro, Durango C.P. 34000	(618) 8121 489
Durango	FERRETERIA DURANGO	20 De Noviembre No. 514 Ote, Centro, Durango Durango, C.P. 34000	(618) 812-2002 (618) 835-2500
Durango	FERREBAÑOS GUADIANA	Bldv. Durango 1222 Col. Fracc. La Pradera, Durango, Durango, C.P. 34150	(618) 813 2000
Durango	GUTIÉRREZ FERRETERO	Bldv. Miguel Alemán y Rayon S/N Col. Centro Gómez Palacio Durango C.P. 35000	(871) 1751 200
San Luis Potosí	PLOMERÍA SELECTA S.A. DE C.V.	Santos Degollado No. 1090 Col. Barrio de Tequisquiapan, San Luis Potosí S.L.P. C.P. 78270	(444) 813-3090 (444) 813-4204
San Luis Potosí	PLOMERÍA POTOSINA S.A. DE C.V.	Tomasa Estévez No. 1100, Col. Alamitos San Luis Potosí C.P. 78280	(444) 812-7927

ZONA PACÍFICO

Sinaloa	MARÍA ESTELA KURODA SAN (CASA KURODA)	Obregón No. 302 Sur, Col. centro, Culiacán Sin. C.P. 80000	(667) 712-1235 (667) 712-1452
Sinaloa	KURODA PLOMERIA Y AZULEJOS S.A. DE C.V.	Carreta internacional s/n Y Flamingos Fracc. Campo Bello, Mazatlán Sin. C.P. 82010	(669) 985-0028 (669) 985-0029
Sinaloa	KURODA PALMITO	Calle Gral. Juan Jose Rios y Jorge Almada Culiacán, Sinaloa C.P. 80200	(667) 716-8070 (667) 712-2104
Sinaloa	KURODA, S.A. KURODA BIENESTAR	Bienestar No. 660 Ote. Col. Centro C.P. 81200 Los mochos Ahome, Sinaloa	(668) 818-6437 (668) 818-6409

ESTADO**DISTRIBUIDOR****DIRECCIÓN****TEL**

Sinaloa	KURODA GUAMÚCHIL	Calle Jesús Rodríguez y Salvador Alvarado N° 305 Col. Militar C.P. 81440 Guamuchil, Sinaloa	(673) 732 3620
Sinaloa	KURODA S.A DE C.V	Blvd. 16 de Septiembre N°1136 Col. Centro C.P. 81000 Guasave, Sinaloa	(667) 716 29 20
Sinaloa	PLOMERÍA Y SANITARIOS DE LOS MOCHIS	Santos degollado S/N Col. Centro C.P. 81200 Los Mochis Sinaloa	(668) 812 4946
Sonora	KS MAYOREO	Periférico Pte. No 81-A, Col Raquet Club, Hermosillo Sonora C.P. 83190	(662) 218-5888 (662) 218-7085
Sonora	KURODA NORTE S.A. DE C.V	Blvd. Josefa Ortiz de Domínguez No.322, Col. Centro, C.P. 83550, Puerto Peñasco, Sonora	(638) 388-1291 (638) 388-1290
Sonora	IVICEVIC	Calz. García López No. 915 entre toba y delicias C.P. 85420 guaymas	(622) 222 0512
B.C.N.	KURODA NORTE S.A. DE C.V.	No 640 Ote. Col. Ex ejido Coahuila, Mexicali B.C.N. C.P. 21360	(686) 500-2020
B.C.N.	KURODA NORTE S.A. DE C.V.	Av. 20 de Noviembre No. 12177, Col. 20 de Noviembre, Tijuana B.C.N. C.P. 22100	(664) 681-2766 (664) 681-2767 (664) 681 9024
B.C.S.	KURODA SAN S.A DE C.V.	Jalisco esq. Yucatán s/n Col. Pueblo Nuevo Municipio La Paz C.P. 23060	(612) 122-7408 (612) 122-2518
B.C.S.	EL FLUXÓMETRO DE CABOS S.A. DE C.V.	Av. Lazaro Cardenas No. 2725 Col. el medano, B. CS. Los Cabos San Lucas. C.P. 23453	(624) 1050-378 (624) 1436-290
B.C.S.	IDICOM	Josefa Ortiz de Dominguez No. 2845, Col. Pueblo Nuevo, La Paz, Baja California Sur C.P. 23060	(612) 125-9803
B.C.S.	EL ARCO LA PAZ	Abasolo 3618 Col. Pueblo Nuevo C.P. 23060 La paz Baja California Sur	(612) 122 7501
Los Cabos	KURODA NORTE	Calle Flor de Pitalla N° 2236 Col. Brisas del Pacifico Los Cabos C.P. 23473	(624) 120-0196
Chihuahua	PINO REAL FERRETERA	Trasviña y retes No. 1308, Col.San Felipe, Chihuahua Chih. C.P. 31240	(614) 414-1089 (614) 413-2344
Chihuahua	MERCANTIL LAVI DE CD. JUÁREZ S.A. DE C.V.	Blvd. Oscar Flores 2850, Fracc. División. Del Norte, Ciudad Juárez Ch. C.P. 32620	(656) 610-6141
Chihuahua	AMBIENTES E INTERIORES S.A. de C.V	Calle 23 No.160, Población Cuauhtémoc, Chihuahua Chih. C.P. 31530	(625) 581-3003



Helvex, S.A. de C.V., Calzada Coltongo 293, Colonia Industrial Vallejo, 02300.
CDMX, Consulta y asesoría en refacciones **Tel.: 55 5333 - 9421**

 **HelvexOficial**

 **@HelvexMx**

 **@HelvexMx**

 **55 8071 7454**

refaccioneshelvex.com.mx



helvex.com.mx

